

HEWLETT-PACKARD JOURNAL

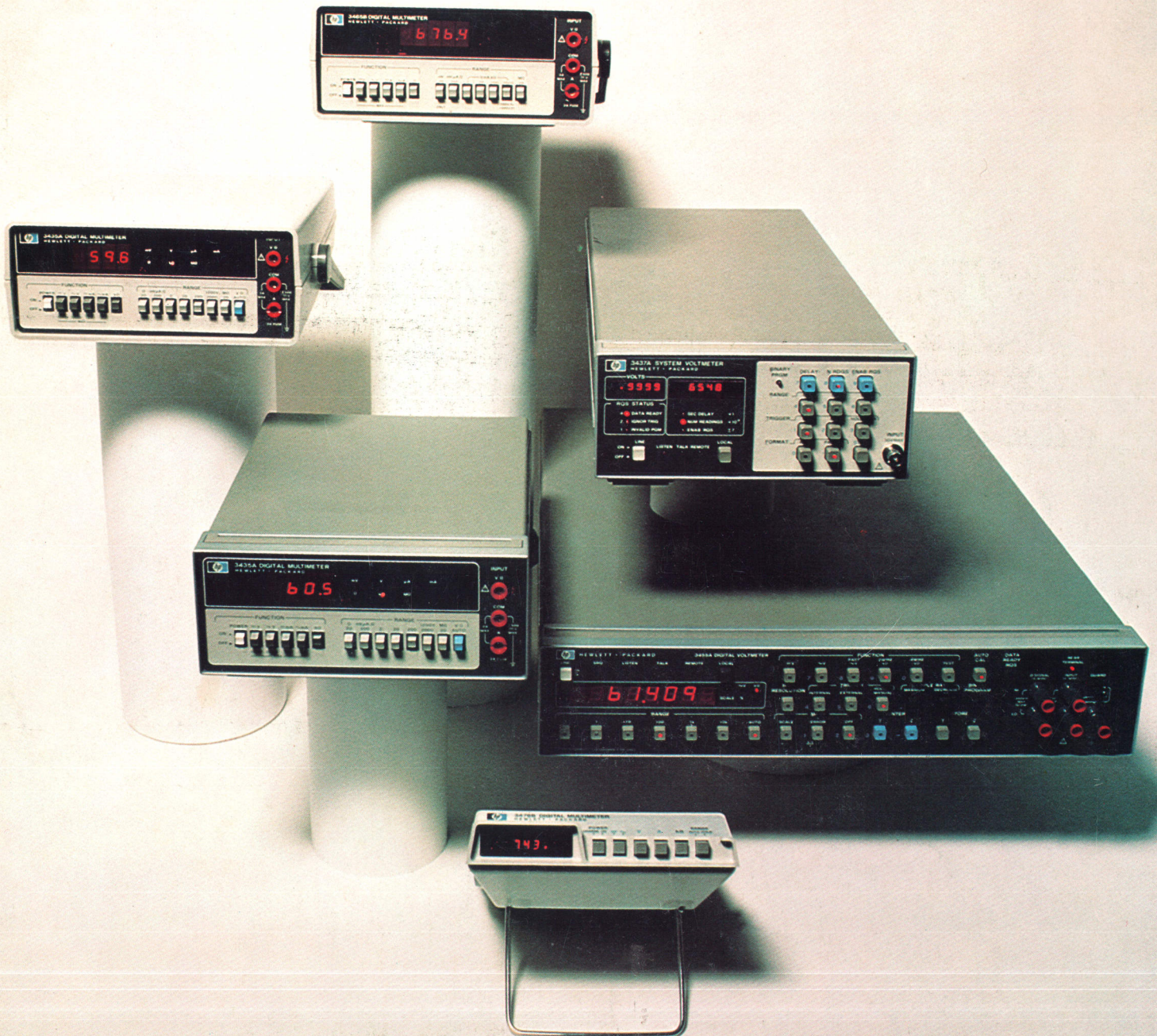

A Fast-Reading, High-Resolution Voltmeter that Calibrates Itself Automatically

Although it has 1- μ V resolution and integrating capability—useful for high-accuracy measurements on the lab bench—this new voltmeter makes 24 readings/second working on the HP interface bus—a boon for systems users. Real-time autocalibration and the ability to perform calculations on its own readings contribute to its versatility.

by Albert Gookin

EMERGING NOW IS A NEW generation of test instruments that use microprocessor-based logic for internal control. The microprocessor can give increased measurement capability while at the same time making the instrument easier to operate, and it can also make the instrument easier to calibrate and maintain.

That is the story behind the new Model 3455A Digital Voltmeter (Fig. 1). An internal microprocessor gives this voltmeter the capability of processing its own readings, thus making it possible to display temperature, for example, when measuring the corresponding voltage output of a thermocouple, or read the percentage deviation of a reading with respect to an earlier reading. Easier operation is also obtained, in this case ease of interfacing it to the HP interface bus[†] for systems use.

Perhaps of greatest significance to most users is the new voltmeter's real-time autocalibration, which gives high accuracy and stability at reduced cost and with simplified calibration and maintenance. Only two calibration adjustments for dc volts and two for ohms are needed. Other calibration adjustments—in the range attenuators and amplifiers—are automatically and repetitively made while the voltmeter is in use. The four basic calibration adjustments are in a plug-in reference module (Fig. 2) that can be taken to the calibration lab without disturbing the voltmeter's input connections. The modules are interchangeable, so the voltmeter can continue operating with a spare reference module replacing the one removed for calibration.

Basic Performance

Model 3455A Voltmeter measures dc volts, ac volts, and ohms. Under programmed control, it can make 24

dc-voltage readings per second with 5½ digit resolution and with 60 dB of normal-mode and 160 dB of common-mode noise rejection (at 60 Hz).* It also has a slower-reading high-resolution mode that displays results with 6½ digits (except on ac voltages and on the 0.1-dcV and 100 Ω ranges). Basic accuracy for dc volts and ohms is 0.005% .

*22 readings/second when operating on 50-Hz power.

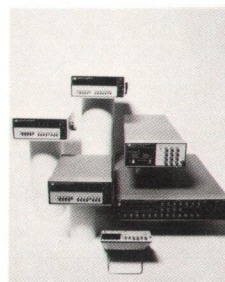

Cover: Voltmeters are the subject of this issue, with descriptions of the capabilities and design ideas found in a variety of instruments ranging from an inexpensive 3½-digit multimeter to a self-calibrating 5½-digit instrument with dual microprocessors. Also of note: new measurement concepts arising from the precise timing capabilities of a new system voltmeter.

In this Issue:

A Fast-Reading, High-Resolution Voltmeter that Calibrates Itself Automatically, by Albert Gookin **page 2**

A High-Speed System Voltmeter for Time-Related Measurements, by John E. McDermid, James B. Vyduna, and Joseph M. Gorin **page 11**

Contemporary Design Practice in General-Purpose Digital Multimeters, by Roy D. Barker, Virgil L. Laing, Joe E. Marriott, and H. Mac Juneau **page 20**

[†]HPP's implementation of IEEE Standard 488-1975.



Fig. 1. Model 3455A Digital Voltmeter measures dc volts, ac volts, and ohms under either manual or systems control. Indicator lights in the pushbuttons show the ranges and functions selected manually or remotely through the HP Interface bus.

Ac voltage readings are normally made at a rate of 1.3/second but a FAST AC mode enables 13 readings per second (under programmed control) on signals having frequencies above 300 Hz. The true-rms converter has a frequency range of 30 Hz to 1 MHz, a crest factor of 7:1, and ac + dc capability. An optional lower-cost averaging ac converter has a frequency range of 30 Hz to 250 kHz.

The input is fully floating and guarded. Full-scale measuring ranges are 0.1V to 1000V in the dc volts mode, 1V to 1000V in the ac volts mode and 100Ω to 10 MΩ in the ohms mode, with 50% overranging.

Interface Compatible

The voltmeter was designed to work with the interface bus specified by IEEE Standard 488-1975 so it has certain programming conveniences built in. For one, it is not necessary to refer to a special table of codes

when programming the instrument—the codes are found on the instrument's front panel. To program the voltmeter for a 2-wire resistance measurement, for example, the system controller sends the code F4. This code was determined by reference to the front panel (see Fig. 3). "F" is the first letter of the FUNCTION group of keys, and is underlined, and the pushbutton "2-WIRE kΩ" is the fourth key from the left in this group. For an on-off function, the code 1 represents on and 0 is off—for example, A1 or A0 for AUTOCAL on or off.

The instrument can also be programmed by setting the controls manually and then causing the system controller to transmit the instrument's "listen" address on the interface bus followed by the code letter B. This puts the instrument in the BINARY PROGRAM mode. The controller then sends the voltmeter's "talk" address, which causes it to output the control settings on the bus in four 8-bit bytes. When these four bytes are subsequently sent back to the voltmeter while in the BINARY PROGRAM mode, it will revert to the same operating configuration that was manually set before.

A row of lights above the display on the front panel (Fig. 4) shows the user the current status of the interface bus, such as LISTEN, for voltmeter being programmed, or TALK, for voltmeter outputting data.

The instrument has a TEST mode that not only verifies operation but that also provides, by the display of

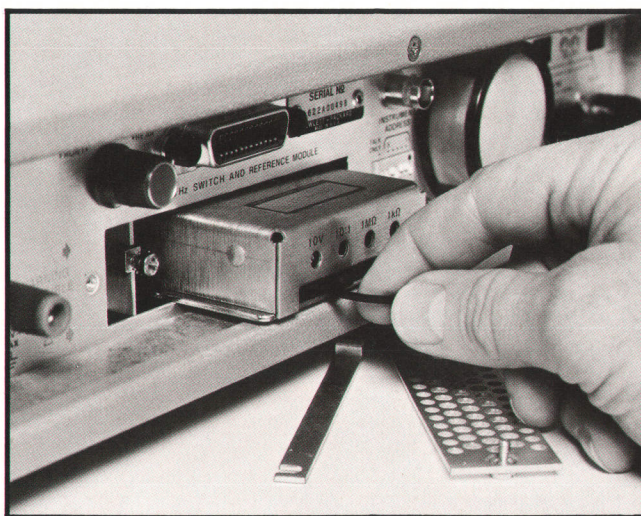

Fig. 2. The four adjustments that calibrate Model 3455A for dc volts and ohms are in a plug-in module that can be taken to the calibration lab. Modules are interchangeable allowing an instrument to continue operating with another calibrated module plugged in.

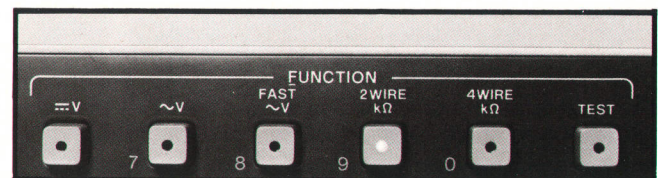

Fig. 3. Programming codes for systems control are labeled on the front panel. An underlined letter, such as the F shown here, is the program code for a group of pushbuttons. A particular pushbutton is specified by its position in the row counting from the left (e.g. the number 3 for FAST ac volts).

certain numbers if something does go wrong, a guide to troubleshooting.

"Math" Function

Many measurements are made with voltmeters not because some electrical quantity is needed directly but because this electrical quantity is related to a

physical quantity that is the real objective of the measurement. The ability to convert readings mathematically to give readout directly in the units desired is built into the new voltmeter.

Because of their general use, two mathematical functions were chosen: percent error and scale. Percent error is stated as $[(X - Y)/Y] \times 100$, where X is the

A Low-Cost, Programmable Data Logger

Model 3455A Voltmeter is combined with a scanner and a calculator by means of the HP interface bus, forming a versatile but inexpensive data logging system, designated Model 3051A.

Under control of the calculator (Model 9815A), the scanner connects signals from transducers and other sources one at a time to the voltmeter's input. The voltmeter measures the signal level (or resistance) and presents the result to the calculator which stores the result on a magnetic tape cartridge for later analysis or, if desired, converts the data to the desired units before storing it. Up to 18,000 six-digit readings can be stored on a single cartridge.

The data-logging system enables data from widely dispersed monitoring points to be gathered at a central station for immediate interpretation and action. Typical applications include:

- Monitoring the chemical constituents of plant effluents and sounding alarms if anything goes out of limits while at the same time providing the graphic records that may be required by some government agencies.
- Testing products or subassemblies while providing a printed record of test results.
- Monitoring the power usage of various pieces of equipment and shutting down various equipment on a priority basis if total power consumption exceeds a level where surcharges are levied by the utility company.
- Monitoring temperatures throughout a large plant to give a centralized view of how efficiently heating or cooling air is being distributed.
- Serving as a fire-alarm monitor to monitor smoke alarms, sprinkler-line flow switches, and hand-activated alarm boxes and then activating various alarms as indicated.

Besides collecting data, the calculator can manipulate the data, such as linearizing thermocouple readings. It can also make decisions based on the voltmeter readings and sound alarms or perform some process function by way of relays in the

scanner. For example, it can monitor the pH or other chemical characteristics of process effluents, and operate valves to introduce neutralizing agents as needed.

This data logging system directly measures the range of electrical quantities that Model 3455A Voltmeter can measure (dc volts, ac volts, and ohms) except that the scanner limits the upper voltage range to 200V. The scanner (Model 3495A) has three reed relays per channel, enabling the voltmeter's guarded input to be extended all the way to the signal sources. Low-level signals may therefore be measured with the excellent common-mode and normal-mode rejection capabilities of the 3455A Voltmeter.

The system can switch, read, and store channels at rates up to 5.3 channels per second for dc measurements, or 4.5 channels per second for resistances and ac voltages (those with signal frequencies above 300 Hz—1 channel per second for lower frequencies). The scanner can also be configured to close two or more channels with a single program command so connections for four-wire resistance or floating bridge measurements are easily made. Up to 40 channels can be handled by the scanner, and the system accommodates two scanners, giving the capability for 80 channels.

The system was designed so it can be operated immediately by a user who has had no programming experience. A pre-recorded tape cartridge supplied with the system asks the user a series of questions by way of the calculator's alphanumeric printer. The user responds with a few keystrokes, usually a 1 for yes, a 0 for no, or a numerical entry such as the range of the voltmeter for a particular channel. Once all the information is in the calculator, a blank cartridge is inserted in the calculator, and the program, properly sequenced, is stored on the cartridge from which it can be loaded into the calculator anytime that program is to be used.

The calculator is supplied with a specially designed ROM that, among other things, includes linearization tables for J, K, and T type thermocouples and a reference junction compensation program. The system also has program storage space for other linearization tables that the user may wish to enter himself.

As a user becomes familiar with the calculator, he can write short subroutines that can be assembled as part of a program by the relocating loader supplied with the system. Writing a program is simply a matter of designating the keystrokes for solving a problem, just as with a hand-held programmable calculator. Branching, conditional instructions and flag manipulation enable the system to make intelligent decisions about the data. FOR-NEXT loops permit program sequences to be repeated a predetermined number of times.

Since the system components are interconnected by means of the HP interface bus, it is relatively easy to add other instruments or peripherals, such as the Model 9871A Impact Printer that can present results in graphic as well as printed form (see box, page 14).





Fig. 4. Indicator lights show the status of the instrument when operating on the HP interface bus.

electrical quantity measured and Y is a number defined by the user. This function is useful in an incoming inspection area, for example, to check the tolerances on resistors and zener diodes with the nominal value entered as the Y quantity.

The other mathematical function, scale, is stated as $(X-Z)/Y$ where again X is the measured quantity, and Y and Z are defined by the user. This function can be used for many transducer measurements, such as measuring temperature with a temperature-sensitive resistor where Z is the resistance at 0°C and Y is the conversion factor ($k\Omega/^\circ C$). With the appropriate quantities entered, this function causes the voltmeter to display temperature when measuring resistance.

By setting $Z=0$, the scale function can also be used

for ratio measurements and with $Y=1$, it can add or subtract offsets to a reading.

The reference numbers can be entered in two ways. One is to use the pushbuttons STORE Y and STORE Z (or program the same buttons via the interface bus). These cause the number currently in the instrument's display to be stored. The other way is to enter the number by first pressing either the ENTER Y or ENTER Z pushbutton and then keying in the number with the pushbuttons that now function as a numerical keyboard. The number entered appears on the display and is stored whenever the STORE Y or STORE Z button is pressed. The same procedure can also be programmed via the interface bus.

Real-Time Autocalibration

The new voltmeter calibrates itself by automatically accounting for gain and offset errors. The basic technique is shown in Fig. 5. By taking readings with the input grounded, then connected to a reference, and finally to the unknown, amplifier offsets and gain errors can be eliminated from the measurement results. A microprocessor can be programmed to do the mathematics indicated, giving a reading that is calibrated to the reference every time a measurement is made.

This technique could be extended to a multirange voltmeter by using a separate voltage reference for each range. This would require at least one calibration adjustment for each range, however, giving the same maintenance problem as any voltmeter without autocalibration.

In the new Model 3455A, this technique is extended to five ranges in such a way that only two calibration adjustments are needed: a +10V reference and a precision 10:1 divider, as described in Figs. 6 and 7. The accuracies of the rest of the components need to be within only a few percent. The +10V reference and the divider are in the reference module that can be removed from the instrument for calibration.

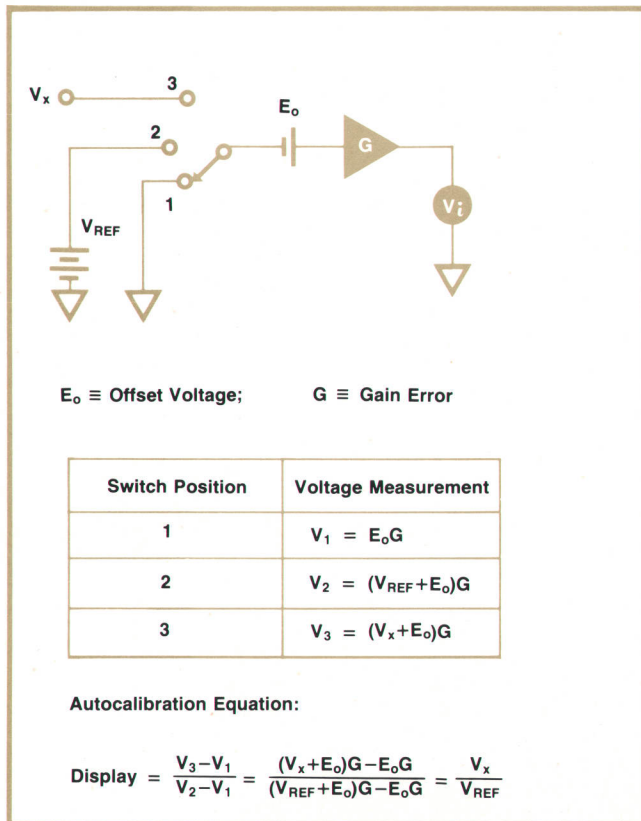

Fig. 5. A technique for improving the accuracy of a single-range voltmeter. The equation shows that errors caused by offset voltages and gain errors are eliminated.

Practical Considerations

Although the description of the autocalibration system implies that a calibration is performed each time a measurement is made, this is not always desirable in practice because it slows the effective reading rate by a factor of three. Nor is it always necessary, because the calibration measurements can be stored and recalled later whenever needed. After a 30-minute warm-up of the Model 3455A, the amplifier gain and offsets change slowly so they do not have to be measured at exactly the same time that the unknown voltage is measured.

The frequency of calibration measurements in the Model 3455A depends upon the operating mode.

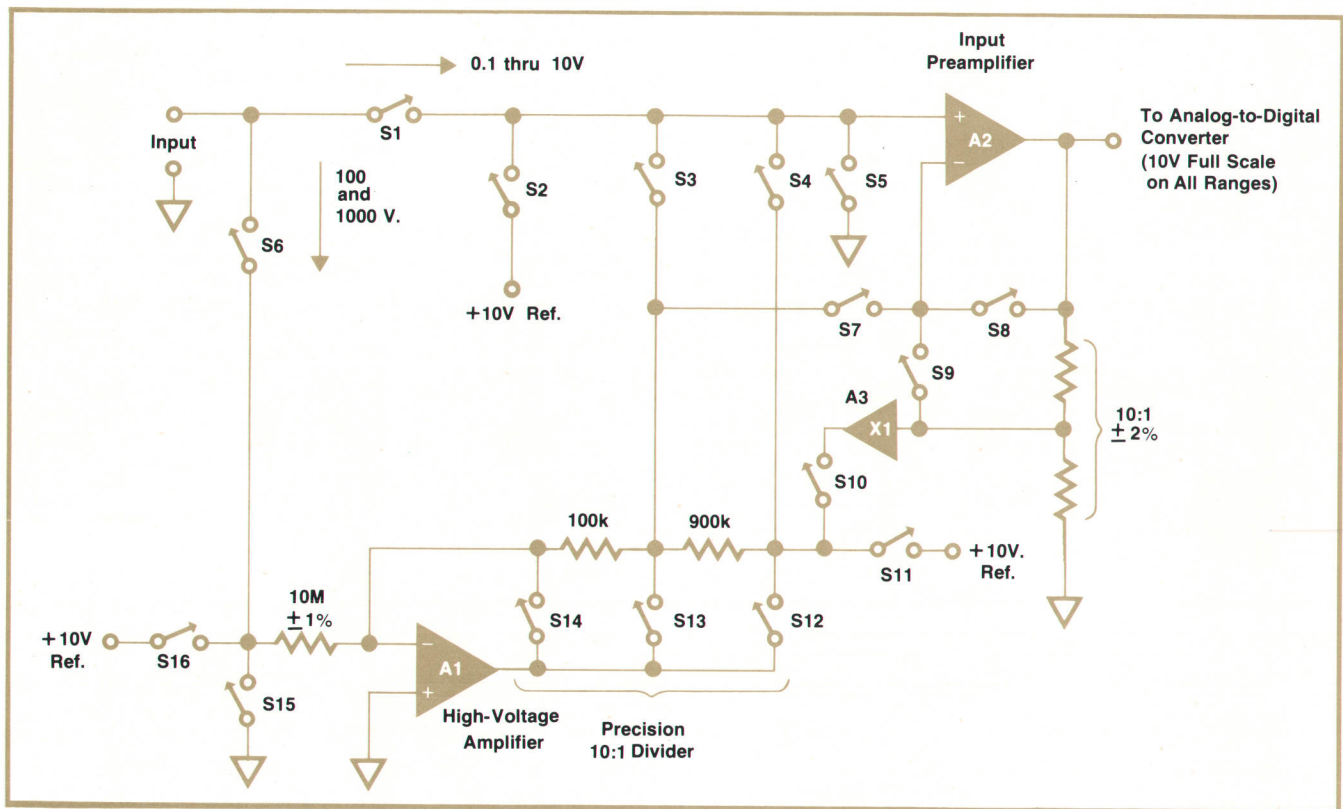

Fig. 6. Simplified diagram of the circuit that performs the autocalibration in the Model 3455A Digital Voltmeter. This circuit scales all inputs to the 0-10V range of the analog-to-digital converter that follows. Besides the +10V reference, the only precision components required are the two resistors in the precision divider, which are physically located in the reference module.

When the instrument is self-triggering (INTERNAL trigger mode), a calibration measurement is made for every measurement of the unknown. If the instrument is in either the MANUAL/HOLD or the EXTERNAL trigger mode, and is not being triggered, it continuously makes the calibration measurements. Then when it is triggered, it aborts the calibration measurement in progress and immediately measures the unknown. However, if the triggers occur too fast for it to ever complete a calibration measurement, it aborts the calibration measurements just 128 times, then delays the trigger long enough to complete a calibration measurement. If delaying the trigger causes a problem, autocalibration can be disabled by a front-panel pushbutton or by a program command.

When the instrument is placed in the self-test mode, all of the autocalibration measurements are compared against internally stored limits. If a measurement is out of tolerance, a number between 1 and 14 is displayed, indicating the source of the problem.

Ohmmeter Autocalibration

A technique for autocalibrating a resistance measurement is shown in Fig. 8. As with voltage autocalibration, three measurements are made and the true value of the unknown found by solving an equation. Again, this technique could be extended to sev-

eral ranges by having a separate reference for each range, which would require several calibration adjustments.

Model 3455A extends this technique to obtain three ranges for each reference resistor, R_{ref} , by using the precision 10:1 divider to control the gain of the amplifier. When the unknown R_x is 10 times R_{ref} , V_3 is 10 times V_2 but these can be brought to the same order of magnitude by using the precision divider in the amplifier's feedback path. This would give the amplifier a $10\times$ greater gain when measuring the values used in the denominator of the equation of Fig. 8 (V_1 is measured twice, once for the numerator and once for the denominator). Similarly, when R_x is $0.1R_{ref}$ the amplifier is programmed to a $10\times$ greater gain when measuring the values used in the numerator.

Thus, three resistance ranges are obtained with each reference resistor. Model 3455A has two reference resistors, both in the reference module, to give six resistance ranges.

The user has a choice of measuring ohms with either a 2-wire or a 4-wire configuration. In the past, 2-wire measurements were made with 4-wire inputs simply by using shorting straps across the terminals. This practice creates a potential hazard to the user if the shorting straps are left in place when the instrument is used for making high-voltage measurements. The conversion from 4-wire to 2-wire is performed

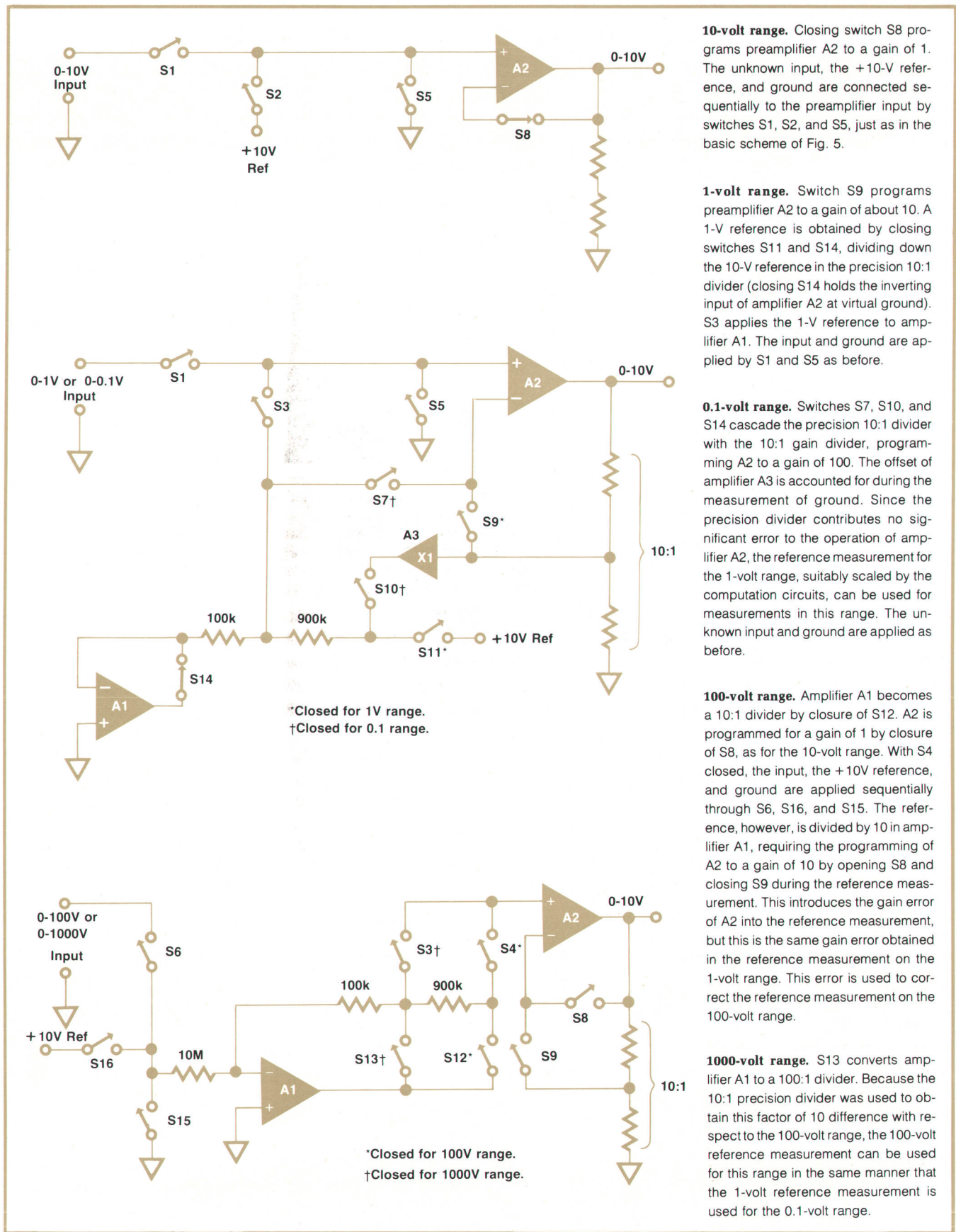

Fig. 7. Switch settings for obtaining five voltage ranges using the circuit of Fig. 6.

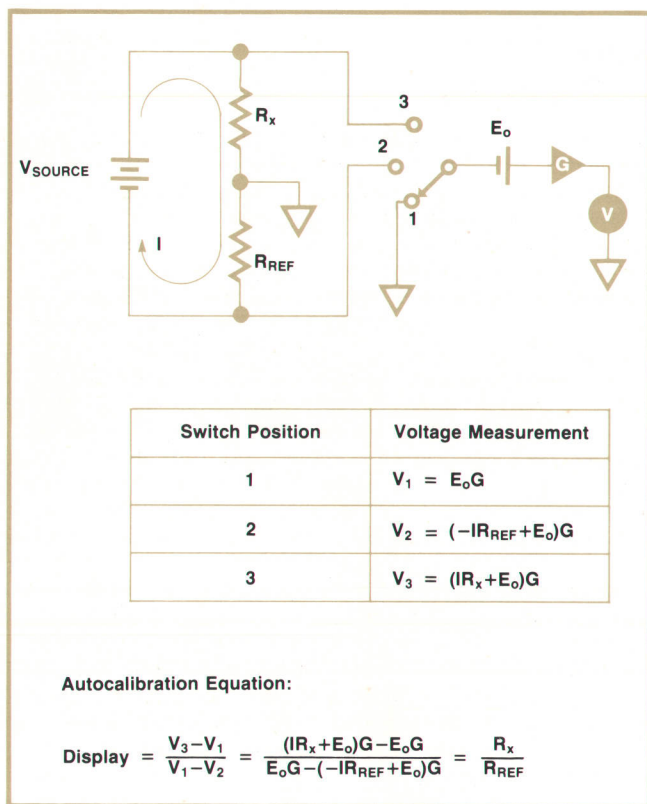

Fig. 8. A technique for calibrating a single range of an ohmmeter. This can be extended to three ranges by programming the amplifier to increase the gain 10× when measuring V_2 or V_3 (and V_1 as appropriate).

internally in the Model 3455A under pushbutton (or programmed) control, eliminating this hazard.

For the system user, being able to program 2-wire or 4-wire measurements as needed can also save the system's multiplexer many scan positions.

A Faster Integrating A-to-D Converter

Most dc voltages encountered in practice have enough normal-mode noise in high-resolution measurements to cause reading errors many times greater than the stated accuracy of the voltmeter. An integrating analog-to-digital converter solves this problem for most cases. Measurement speed, on the other hand, is important for systems applications. This conflicts with the need to integrate the measured voltage over a sufficiently long time to eliminate the effects of normal-mode noise.

Dual-slope conversion, the technique most widely used in integrating digital voltmeters, charges an integrating capacitor at a rate proportional to the input voltage for 1/60 second (1/50 second in instruments operating on 50-Hz power). At the conclusion of this charging interval, the capacitor is discharged at a rate proportional to a known reference voltage. The time required for the capacitor to discharge to the starting

level is proportional to the acquired charge on the capacitor, which in turn is proportional to the input voltage. This time interval is measured to derive a digital indication of the input voltage.

With the time needed for an autozero operation and for stabilizing the circuits, this technique requires about 50 ms or more for each conversion. A faster conversion time was wanted for the Model 3455A so the reading rate could be on the order of 25/s. This was achieved by overlapping the integrator charge and discharge phases of the measurement cycle. The technique for doing this is described in the box at right.

Instrument Organization

A simplified block diagram of the Model 3455A Voltmeter is shown in Fig. 9. Since the voltmeter has a fully floating, guarded input, an optical interface is used to couple control signals and measurement information into and out of the guarded portion of the instrument. The voltmeter output may thus be connected to ground while the input is measuring a voltage that may be floating up to several hundred volts above ground.

Two microprocessors are used: one for control of the in-guard circuits and one for the out-guard cir-

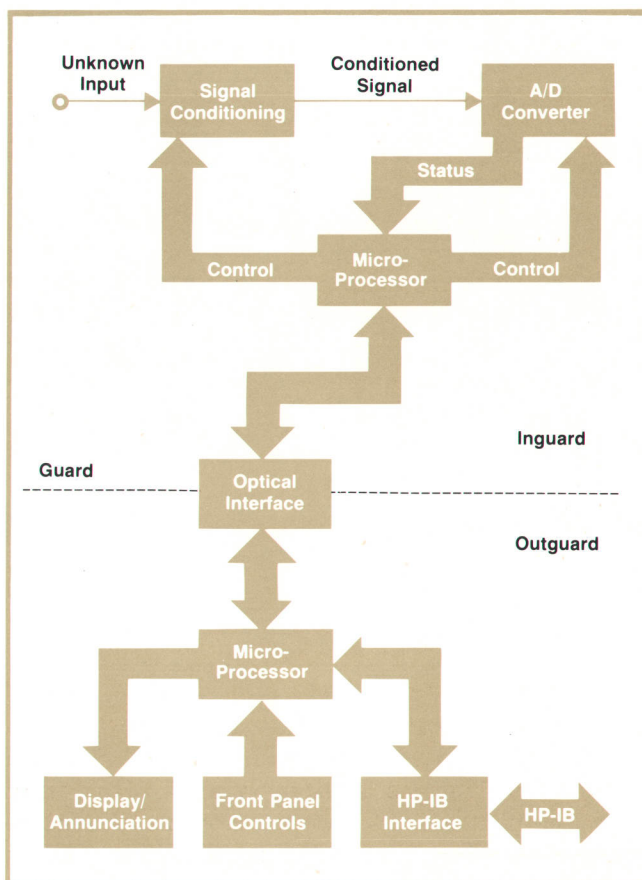

Fig. 9. Organization of Model 3455A Digital Voltmeter.

A Faster Integrating Analog-to-Digital Converter

The A-to-D converter used in the Model 3455A Digital Voltmeter is shown in the skeleton circuit diagram below. Integration is performed by amplifier A1 and capacitor C in response to two sources of charge: the unknown voltage, V_{in} , and a reference voltage, $-V_R$, that is opposite in polarity to V_{in} .

The integrator output level is monitored by two comparators, C1 and C2. These detect the zero voltage level and a level called $-V_{comp}$. The value of $-V_{comp}$ is not critical as long as it is less than the saturation voltage of amplifier A1.

At the start of a measurement, the integrator capacitor, C, has no charge on it. Switch S1 closes so the integrator output voltage, V_{int} , starts going negative as C charges in response to the positive voltage at the input. At the same time, the START SAMPLE signal from the control logic goes true, allowing clock pulses to accumulate in the sample period counter.

When V_{int} reaches the $-V_{comp}$ level, the voltage transition generated by comparator C2 causes the control logic to close switch S2. The current supplied by the reference voltage, $-V_R$, causes the integrator output to reverse direction, as shown by the plot below. This continues for a fixed time interval, t_c . During this time interval, the COUNT ENABLE signal is true, allowing clock pulses to accumulate in the display counter.

At the end of time interval t_c , the COUNT ENABLE signal goes false and switch S2 is opened. V_{int} then goes in a negative direction again.

This alternate charging and discharging of the integrator continues until 200,000 counts accumulate in the sample period counter. When it overflows, S1 opens, S2 closes (if not already closed) and the COUNT ENABLE signal goes true (if not already true). The integrator output then returns rapidly to zero volts, which causes comparator C1 to signal the control logic to open S1 and stop the accumulation of counts in the display counter. The count in the display counter is now proportional to the unknown input, V_{in} , as shown by the equation.

By making the sample period, T, 16-2/3 ms (or 20 ms when operating on 50-Hz power lines), integration of the unknown occurs for exactly one cycle of the power-line frequency, giving good rejection of power-line interference. Total conversion time is only slightly greater than the sample period so the reading rate is potentially much faster than the desired 25 readings/second (actual reading rate is limited by the time required to output each reading).

During the autocalibration cycle, the sample period and display counters are increased by a factor of 10 to give a total capacity of 2,000,000 counts for each. The order of magnitude increase in measurement resolution reduces the errors caused by working with finite numbers when calculating the measurement number to be displayed. This increased resolution is made available for the measurement of unknowns by the HIGH RESOLUTION pushbutton.

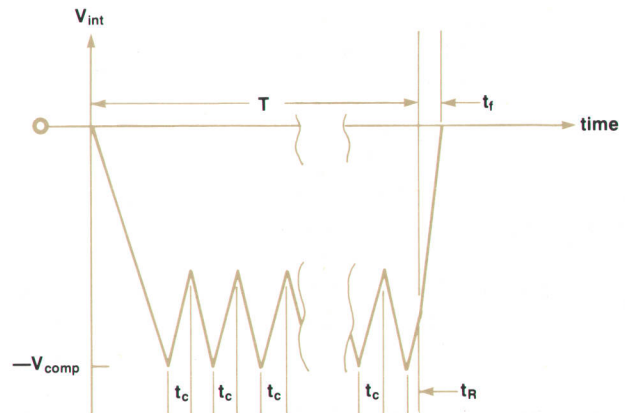
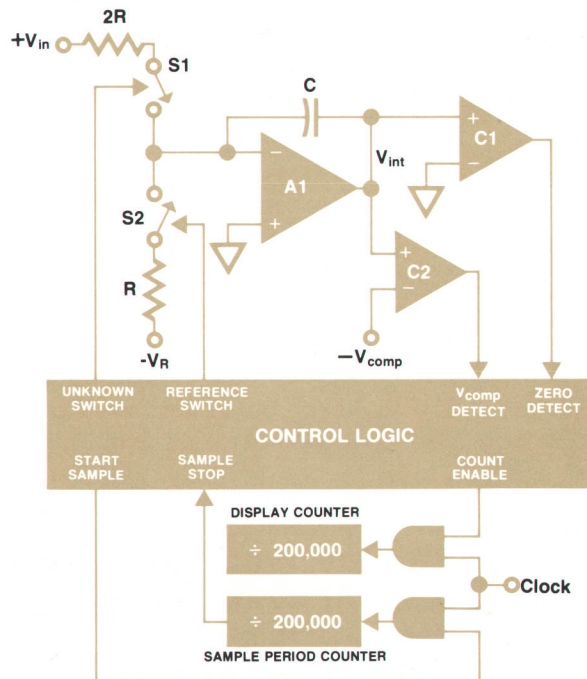

Charge Balance Equation:

$$\frac{V_{in}T}{2R} = \frac{V_R n t_c}{R} + \frac{V_R t_R}{R} + \frac{V_R t_f}{R}$$

where n = number of t_c 's during T (depends on V_{in}).

$$\text{or } \frac{V_{in}}{V_R} = 2 \left[\frac{n t_c + t_R + t_f}{T} \right]$$

cuits. Using one microprocessor to perform both functions would have required a very expensive optical interface, so the two-microprocessor approach was chosen. The microprocessors are an HP design that uses parallel architecture optimized for high-speed control functions at the expense of arithmetic capability.

The two controllers run in locked step. First, the

out-guard controller determines the next task to be done and it then transfers the necessary control information to the in-guard controller, which sets up the proper signal conditioning and controls the A-to-D cycle. After the A-to-D cycle is completed, the in-guard controller transfers results to the out-guard controller. If the result is from an unknown input, the out-guard controller computes the reading and dis-

plays it. If it is from a calibration measurement, it stores the result. The sequence then repeats.

Acknowledgments

Reid Gardner, Tom Heger and Bill Nicolay designed the logic hardware and wrote the firmware. Francis Fiedler, DeLloy Forbes, Jim Ressemeyer, and Steve Venzke designed the analog circuits. Mike Williams was responsible for the mechanical design and Barry Taylor contributed to the early mechanical layout. Industrial design was by Jim Berry. Special thanks are due Engineering Lab Manager Bill Kay for wanting autocalibration, and to Section Manager Jerry Nelson, who provided day-to-day assistance and whose thorough evaluation made the 3455A a better voltmeter. Thanks are also due Chuck Pfenning and Ben Lizardi for easing the release to production.



Albert Gookin

On joining Hewlett-Packard in 1965, Al Gookin initially worked on the Model 3460B Digital Voltmeter, continuing on with Models 3461A, 3462A, and 3450A, the 3403A True-rms Voltmeter and, as project manager, the 3470 Measurement System. He then contributed to the 3495A Scanner before becoming project manager for Model 3455A. Al's a graduate of the University of California at Berkeley (BSEE) and he earned an MSE at Colorado State University in the HP Honors Co-op program.

For relaxation, Al likes motorcycling, stamp and coin collecting, and landscaping. He and his wife have one son, 12.

SPECIFICATIONS
HP Model 3455A Digital Voltmeter

DC Voltage

RANGES/MAXIMUM DISPLAY:

	High Resolution Off	High Resolution On
0.1V	±1.49999V	
1V	±1.49999V	±1.499999V
10V	±14.9999V	±14.99999V
100V	±149.999V	±149.9999V
1000V	±1499.99V	±1499.999V

RANGE SELECTION: Manual, Automatic, or Remote
PERFORMANCE (HIGH RESOLUTION OFF)
ACCURACY (90 days; 23°C ±5°C):
10V RANGE: ±(0.005% of reading + 1 digit)
1V RANGE: ±(0.006% of reading + 1 digit)
0.1V RANGE: ±(0.007% of reading + 4 digits)
100 & 1000V RANGE: ±(0.007% of reading + 1 digit)
TEMPERATURE COEFFICIENT (0°C to 50°C):
0.1V RANGE: ±(0.0003% of reading + 0.15 digits)/°C
1V RANGE: ±(0.0003% of reading + 0.015 digits)/°C
10V RANGE: ±(0.00015% of reading + 0.01 digits)/°C
100 & 1000V RANGE: ±(0.0003% of reading + 0.01 digits)/°C
PERFORMANCE (HIGH RESOLUTION ON)
ACCURACY (90 days; 23°C ±5°C):
10V RANGE: ±(0.005% of reading + 3 digits)
100 & 1000V RANGE: ±(0.007% of reading + 3 digits)
1V RANGE: ±(0.006% of reading + 4 digits)
TEMPERATURE COEFFICIENT (0°C to 50°C):
1V RANGE: ±(0.0003% of reading + 0.15 digits)/°C
10V RANGE: ±(0.00015% of reading + 0.1 digits)/°C
100 & 1000V RANGE: ±(0.0003% of reading + 0.1 digits)/°C

INPUT CHARACTERISTICS
INPUT RESISTANCE:
0.1V through 10V RANGE: > 10⁹ ohms
100V and 1000V RANGE: 10 megohm ±0.1%
MAXIMUM INPUT VOLTAGE:
High to low input terminals: ±1000V peak
Guard to chassis: ±500V peak
Guard to low terminal: ±200V peak
NORMAL MODE REJECTION (NMR): >60 dB at 50 or 60 Hz ±0.1% (NMR is the ratio of the peak normal-mode voltage to peak error voltage in the reading.)
EFFECTIVE COMMON MODE REJECTION (ECMR):
At dc, >140 dB with 1 kΩ imbalance in low lead.
At 50 or 60 Hz ±0.1%, >160 dB with 1 kΩ imbalance in low lead.
(ECMR is the ratio of the peak common-mode voltage to resultant peak error voltage in the reading.)

MAXIMUM READING RATE:

	60Hz Gate Length	
	High Resolution Off	High Resolution On
Local	5 readings/sec.	3 readings/sec.
Remote	24 readings/sec.	6 readings/sec.
	50Hz Gate Length	
	High Resolution Off	High Resolution On
Local	3.5 readings/sec.	2.5 readings/sec.
Remote	22 readings/sec.	5 readings/sec.

Ohms

RANGES/MAXIMUM DISPLAY:

	High Resolution Off	High Resolution On
0.1kΩ	±1.49999kΩ	
1kΩ	±1.49999kΩ	±1.499999kΩ
10kΩ	±14.9999kΩ	±14.99999kΩ
100kΩ	±149.999kΩ	±149.9999kΩ
1000kΩ	±1499.99kΩ	±1499.999kΩ

RANGE SELECTION: Manual, Automatic, or Remote
FUNCTION SELECTION: 2-wire k ohms or 4-wire k ohms
PERFORMANCE (HIGH RESOLUTION OFF)
ACCURACY, 4-wire k ohms (90 days; 23°C ±5°C):
0.1kΩ RANGE: ±(0.005% of reading + 5 digits)
1kΩ RANGE: ±(0.005% of reading + 1 digit)
10kΩ RANGE: ±(0.007% of reading + 2 digits)
100kΩ RANGE: ±(0.004% of reading + 2 digits)
1000kΩ RANGE: ±(0.014% of reading + 5 digits)
10,000kΩ RANGE: ±(0.100% of reading + 5 digits)
TEMPERATURE COEFFICIENT (0°C to 50°C):
0.1kΩ RANGE: (0.0003% of reading + 0.2 digits)/°C
1, 10 and 100kΩ RANGE: (0.0003% of reading + 0.02 digits)/°C
1000kΩ RANGE: (0.0005% of reading + 0.02 digits)/°C
10,000kΩ RANGE: (0.004% of reading + 0.02 digits)/°C
PERFORMANCE (HIGH RESOLUTION ON)
ACCURACY, 4-wire k ohms (90 days; 23°C ±5°C):
1kΩ RANGE: ±(0.0035% of reading + 5 digits)
10kΩ RANGE: ±(0.006% of reading + 5 digits)
100kΩ RANGE: ±(0.0035% of reading + 6 digits)
1000kΩ RANGE: ±(0.0135% of reading + 5 digits)
10,000kΩ RANGE: ±(0.100% of reading + 5 digits)
TEMPERATURE COEFFICIENT (0°C to 50°C):
1, 10 and 100kΩ RANGE: ±(0.0003% of reading + 0.2 digits)/°C
1000kΩ RANGE: ±(0.0005% of reading + 0.2 digits)/°C
10,000kΩ RANGE: ±(0.004% of reading + 0.2 digits)/°C
ACCURACY, 2-wire k ohms: the same as 4-wire k ohms except add 0.0004kΩ to all readings.

INPUT CHARACTERISTICS
MAXIMUM VOLTAGE GENERATED ACROSS UNKNOWN:
<5 volts for open circuit
<4.7 volts for valid reading
SIGNAL SOURCE DRIVING UNKNOWN (NOMINAL):

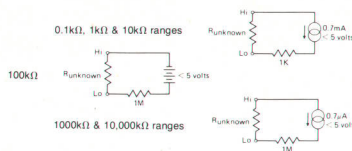

OVERLOAD PROTECTION: Non-destructive, ±350V peak
MAXIMUM READING RATE:

	60Hz Gate Length		High Resolution On
	High Resolution Off	High Resolution On	
Local	4.5 readings/sec.	12 readings/sec.	2 readings/sec.
Remote			3 readings/sec.
	50Hz Gate Length		High Resolution On
	High Resolution Off	High Resolution On	
Local	4 readings/sec.	11 readings/sec.	1.8 readings/sec.
Remote			2.5 readings/sec.

AC Voltage

RANGES/MAXIMUM DISPLAY:
HIGH RESOLUTION ON OR OFF
1V 1.49999V
10V 14.9999V
100V 149.999V
1000V 1499.99V
RANGE SELECTION: Manual, Automatic, or Remote
FUNCTION SELECTION: ACV or Fast ACV

PERFORMANCE (RMS Converter)
ACCURACY (90 days; 23°C ±5°C):
ACV/ACV FAST (% of reading + no. of digits)
30 Hz/300 Hz—20 kHz: 0.05% ± 40
20 kHz—100 kHz: 0.5% ± 100
100 kHz—250 kHz: 2.0% ± 250**
250 kHz—500 kHz: 5% ± 500**
500 kHz—1 MHz: 6% ± 2000**
*With guard connected to low, ac coupling, and input ≥ 1% of range; for input < 1% of range and for ac/dc coupling, add 0.05% of reading + 20 digits.
On 1000V range, add 0.01 ppm/volt-kHz.
**Specified on 1V and 10V ranges only.
TEMPERATURE COEFFICIENT (0°C to 50°C): ±(0.002% of reading + 6 digits).
CREST FACTOR: 7:1 at full scale
PERFORMANCE (Average Converter, opt. 001)
ACCURACY (90 days; 23°C ±3°C):
ACV FAST (% of reading + no. of digits)
30—50 Hz 300—500 Hz 0.5% ± 70
50—100 Hz 0.5—1 kHz 0.35% ± 50
0.1—100 kHz 1—100 kHz 0.1% ± 25
100—250 kHz 100—250 kHz 0.75% ± 60**

*With guard connected to low and input > 1% of range; on 1000V range, add 0.01 ppm/volt-kHz.
**Specified on 1 and 10V ranges only.
TEMPERATURE COEFFICIENT (0°C to 50°C): ±(0.002% of reading + 2 digits)/°C.
INPUT CHARACTERISTICS
INPUT IMPEDANCE:
Front Terminals, 2MΩ ± 1% shunted by less than 90pF.
Rear Terminals, 2MΩ ± 1% shunted by less than 65pF.
MAXIMUM INPUT VOLTAGE:
High to Low terminals: ±1414 volts peak (subject to a 10⁷ volts-Hz limitation)
Guard to Chassis: ±500V peak
Guard to Low Terminal: ±200V peak
MAXIMUM READING RATE:

	60Hz Gate Length		FAST ACV
	Local	Remote	
ACV	1.3 readings/sec.	1.3 readings/sec.	4.5 readings/sec.
FAST ACV			13 readings/sec.
	50Hz Gate Length		FAST ACV
	Local	Remote	
ACV	1.1 readings/sec.	1.1 readings/sec.	3.5 readings/sec.
FAST ACV			12 readings/sec.

RESPONSE TIME (ACV and FAST ACV): First reading within <0.1% of step top when triggered coincident with step change while on correct range (for ac signals with no dc component).

Math
SCALE (X-Z)/Y: X is present reading, Y and Z are previously entered readings, numbers entered from front panel or by external program.
MAXIMUM NUMBER (Entered or Displayed): ±199,999.9
ACCURACY: ±(ACCURACY OF X READING ± 1 DIGIT OF DISPLAYED ANSWER), assuming no Y or Z error.
% ERROR ± 100%: X is present reading, Y is previously entered reading or number entered from front panel or by external program.
MAXIMUM NUMBER (Entered or Displayed): ±199,999.9
ACCURACY: ±(ACCURACY OF X READING ± 1 DIGIT OF DISPLAYED ANSWER) assuming no Y error.

General
(Autocal must be on for 75 seconds to meet all specifications)
WARMUP TIME: One hour to meet all specifications.
POWER: 100/120/220/240V ±5%, -10% 48Hz to 400Hz line operation <60VA.
WEIGHT: 9kg, 21 lbs.
DIMENSIONS: 86.9 mm high × 425.5 mm wide × 527.1 mm deep (3 1/8" × 16 3/4" × 20 3/4" inches).
PRICE IN U.S.A.: Model 3455A, \$3,200.; Average Converter (Option 001), less \$200.
MANUFACTURING DIVISION: LOVELAND INSTRUMENT DIVISION
815 Fourteenth Street, S.W.
Loveland, Colorado 80537 U.S.A.

A High-Speed System Voltmeter for Time-Related Measurements

Waveform characteristics as well as dc levels can be determined by this fast sample-and-hold voltmeter when teamed with a calculator or computer. Optimized for systems use, it has a programmable trigger delay that gives it unusual capabilities.

by John E. McDermid, James B. Vyduna, and Joseph M. Gorin

THE TIME AT WHICH A VOLTAGE is measured can provide as much meaningful information as the magnitude and sign of the voltage measurement itself. Consider, for example, the sine wave shown in Fig. 1. If instantaneous voltage measurements are made at the two points P and Q, and if the time lapse between these points is equivalent to a phase difference of 90° , then the amplitude can be derived by use of the trigonometric identity, $\sin^2(\omega t + \theta) + \cos^2(\omega t + \theta) = 1$.

Hence, by the use of some a priori knowledge, specifically the frequency and shape of the waveform, the magnitude of a relatively pure sine wave can be determined from measurements made within one quarter cycle of the waveform. By comparison, a typical voltmeter may require eight to ten cycles of the waveform to obtain a valid measurement and may not even be able to measure it at all, if the frequency is too low. The increase in measurement speed provided by the technique of Fig. 1 can have a significant effect on the attainable throughput of a data acquisition system.

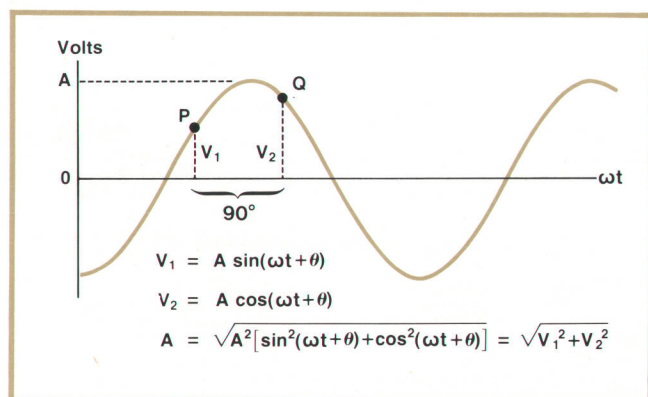

Fig. 1. By measuring the instantaneous level of a sine wave at two points, P and Q, 90° apart, the peak amplitude and rms values of a sine wave can be calculated. Points P and Q can occur anywhere in the waveform as long as the 90° relationship is preserved.



Fig. 2. Model 3437A Systems Voltmeter is a fast sample-and-hold voltmeter designed to work with a calculator or computer in a systems environment.

Sampling Measurements

To enable time-dependent measurements like that just described, a new voltmeter, Model 3437A (Fig. 2), has been designed to sample a voltage and to coordinate that event with a specific point in time. When teamed with a calculator or computer, the new voltmeter provides raw data, measured in volts, from which the calculator or computer can derive a large variety of ac waveform characteristics, as well as dc levels. These characteristics include peak value, rms value, rise time, frequency, distortion, spectral content and many others, limited only by the ingenuity of the user. This voltmeter can thus replace an accumulation of instruments that a system would otherwise need to measure all these quantities.

Model 3437A evolved from the observation that the majority of measurements made by a systems voltmeter require accuracies no better than 0.5%. A resolution of $3\frac{1}{2}$ digits is therefore sufficient. Coupled with a successive-approximation type analog-to-

digital converter and fast-responding input circuits, this allows the new voltmeter to settle in $1.5 \mu\text{s}$ within 3 mV of a 1-volt step input, and to output the voltage magnitude and sign less than $200 \mu\text{s}$ later.

Of what use is this speed? First of all, it enables a data acquisition system to make many measurements practically simultaneously, when measured on the time scale of most processes. This would be useful for examining changing temperature profiles, for example, during studies of heat flow. When teamed with a Model 9825A Calculator and a Model 3495A Scanner, Model 3437A can measure channels at a rate of 125 channels per second with up to $100\text{-}\mu\text{V}$ sensitivity.

This measurement speed can have a significant effect on systems economics, particularly for production test systems where the time taken to run through a test sequence is a significant part of the time taken to handle the device under test. The ac voltage measurement technique described in Fig. 1 is an example of the speedup that the new voltmeter makes possible.

Another example concerns measurements of dc voltages contaminated with ac line interference (Fig. 3). If two samples of this voltage, separated by a time equivalent to 180° of the interfering ac frequency, are taken and averaged, the interfering frequency and all its odd harmonics can be rejected.

The measurement speedup made possible by this technique can be illustrated by an example. Suppose that a system is required to measure five dc channels that have 60-Hz interference. The voltmeter's trigger interval is set to 0.8333 ms and the multiplexing arranged so that the 1st and 6th samples are taken from channel 1, the 2nd and 7th from channel 2, and so on. Then within a 1/60-second period, each channel con-

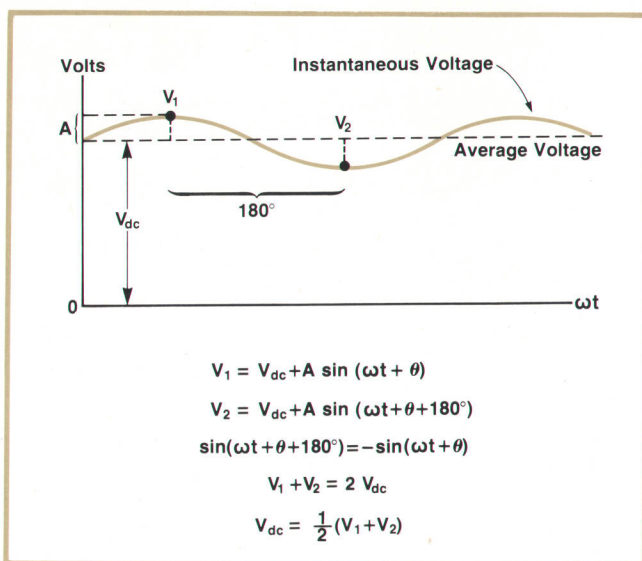

Fig. 3. By appropriate spacing of two samples, an interfering ac voltage can be eliminated from a measurement of a dc voltage.

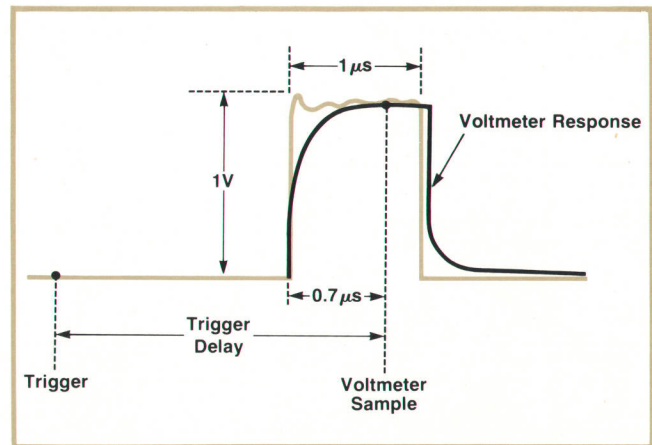

Fig. 4. Model 3437A Systems Voltmeter can be programmed to sample and read the amplitude of a pulse at a point in time precisely related to a trigger by the voltmeter's programmable delay. Uncertainty (jitter) in the location of the sample is less than 10 ns. The voltmeter will be accurate to at least 2% within $0.7 \mu\text{s}$ after the pulse leading edge.

tributes two data points 1/120 second apart. Hence, five channels are scanned in 1/60 second plus a little calculating time, and the 60-Hz interference is rejected. This is about five times faster than an integrating voltmeter could accomplish the same task.

Digitized Waveforms

One of the significant capabilities of Model 3437A is its programmable delay, which allows the instant of sampling to be delayed in $0.1\text{-}\mu\text{s}$ increments up to one second with respect to a trigger. This enables the voltmeter to "capture" important values of rapidly changing waveforms, such as measuring the amplitude of a pulse (Fig. 4).

Another significant capability is its ability to make measurements in bursts, where several measurements are made in response to a single trigger, as shown in Fig. 5. Up to 9999 measurements can be made in each burst with the time interval between each measurement precisely established by the DELAY function.

The minimum time between each measurement in a burst is determined by two factors. First is the time needed to acquire a sample, digitize it, and prepare it for output (listed in the specifications, page 19, as the minimum delay for $N \text{ Rdgs} > 1$). Second is the time needed by the "listening" instrument, usually a calculator or computer, to accept data (the voltmeter provides no storage for readings). With a 9825A Calculator as the controller, the new voltmeter can make burst measurements on a single channel at rates greater than 4500 readings per second. This rate enables low-frequency waveforms to be digitized with many closely-spaced samples. The calculator can then operate on the samples, such as performing a Fourier transform on the measured values to obtain the spec-

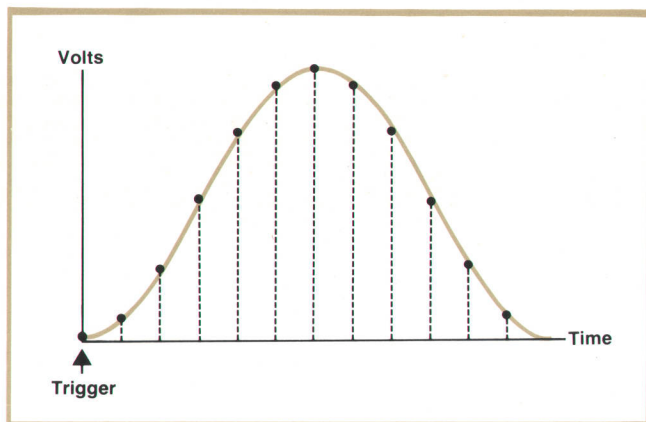

Fig. 5. When making measurements in bursts, Model 3437A takes several readings in response to a single trigger, 12 in this example. The time between measurements is established by the DELAY function.

trum of a transient or deriving a measure of waveform distortion and other characteristics (see box, page 14).

The DELAY function can also be used for measurements on high-speed repetitive waveforms. As shown in Fig. 6, the delay can be reprogrammed following each measurement so the next sample occurs at a slightly later point in the waveform in the same way that a sampling oscilloscope samples a waveform. With the samples thus obtained, the calculator or computer can derive waveform characteristics such as amplitude, distortion, and so on. With the delay programmable in 0.1- μ s increments, this enables one cycle of a 500-kHz waveform to be represented by 20 samples, giving an effective sampling rate of 10 MHz.

Instrument Operation

Model 3437A has three floating input ranges: ± 100 mV, ± 1 V, and ± 10 V with a maximum display of ± 1998 (and appropriately positioned decimal point). It was designed from the ground up to be a systems voltmeter working on the HP interface bus,* hence the front-panel arrangement differs somewhat from conventional voltmeters. All functions are programmable so the major objective of the front-panel layout was to provide a monitor and software debugging aid, rather than the primary method of control. All the programmed states of the instrument are annunciated on the front panel, allowing program flow to be monitored. As a further aid to debugging, one indicator (INVALID PGM) shows when a wrong program command has been received by the instrument.

Of the two numeric displays, one indicates the measured voltage. The other gives the trigger delay, or the number of readings to be taken in a burst, or, by a code number, the events that will cause the SRQ (service request) line on the interface bus to go true.

There is a one-to-one correspondence between

*Hewlett-Packard's implementation of IEEE Standard 488-1975

front-panel keys and program commands. All key-per-function commands are two characters long, the first being an alphabetical character corresponding to the desired function and the second being a number that describes the position of the key in the selected row, e.g. R3 is the program code for the 10-volt range and T2 is for external trigger (see Fig. 2). Data entries are preceded by an alphabetical character followed by the data and terminated with S, the first letter of the STORE key. For example, D.001S programs the voltmeter for a 1-ms trigger delay.

Rather than program each key by separate instructions, the voltmeter can be completely programmed with seven bytes of information, properly formatted, when operating in the BINARY PROGRAM mode, the same as Model 3455A (see article preceding). This mode minimizes the time needed on the interface bus to program the instrument, an especially important consideration when several instruments may be operating on the bus at the same time. It also reduces storage requirements on the controller.

The instrument can also be set up manually then, when programmed to be in the BINARY PROGRAM mode, the program states can be transferred in seven bytes to the controller. The BINARY PROGRAM mode is also useful as an autoverification routine for testing the interface bus—the controller can program the voltmeter, then request return of the program information for comparison with that sent.

Initiating a Measurement Sequence

Readings may be initiated in four ways. Three of these (INT, EXT, HOLD/MANUAL) can be selected by front-panel keys or related program codes. The fourth is an interface code (GET, for group execute trigger) that initiates a measurement through the interface bus regardless of the trigger mode programmed.

HOLD/MANUAL is the trigger mode most often used for programming. When first sent to the voltmeter, the code T3 puts the voltmeter into the HOLD/MANUAL

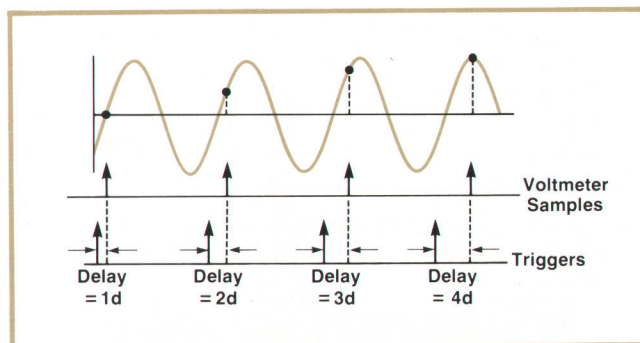

Fig. 6. By reprogramming the delay following each measurement, a higher frequency repetitive waveform can be sampled for analysis the same way a sampling oscilloscope reconstructs a waveform.

mode. Each subsequent T3 then triggers it just as though the front-panel HOLD/MANUAL pushbutton were pressed.

In the EXTERNAL mode, the voltmeter responds to TTL negative transitions supplied to a rear-panel input. If a trigger occurs before data from the previous trigger has been output, the trigger will be ignored and the IGNOR TRIG indicator will light and its internal status line will go true.

The INTERNAL mode operates in two ways depending on whether the voltmeter is controlled locally or remotely. In local control, the INTERNAL mode gener-

ates triggers continuously at a rate of about 10/s. Under remote control, INTERNAL generates a trigger on the transition of the interface bus ATN line to false. When ATN (attention) is true, it causes devices operating on the bus to recognize codes on the data lines as addresses. The transition to false then indicates that all addressing is complete. How this affects voltmeter operation can be illustrated by an example.

Suppose a system calculator addresses the voltmeter to "listen" and then sends it commands to take 10 readings in a burst with a delay of 300 μ s, followed by a T3 (HOLD/MANUAL) trigger code. The calculator

A Programmable Data Acquisition System that also Analyzes

Model 3437A System Voltmeter is a component of the new Model 3052A Programmable Data Acquisition System. This system, controlled by a Model 9825A Calculator, also includes a Model 3455A Voltmeter and a Model 3495A Scanner. It has all the capabilities of the Model 3051A Programmable Data Logger (page 4) plus much more, such as low-frequency waveform analysis, and three-dimensional plotting.

Model 3455A Voltmeter gives the system high accuracy, high sensitivity and excellent noise rejection with a maximum system reading rate of 19 dc channels per second with 1- μ V resolution, or 10 channels per second when measuring ac volts and 11 on ohms (16.5, 9.5, and 10 on 50-Hz power). Model 3437A System Voltmeter gives the capability for high reading rates—up to 125 channels per second with 0.1-mV resolution and more than 4900 3½-digit readings per second on a single channel.

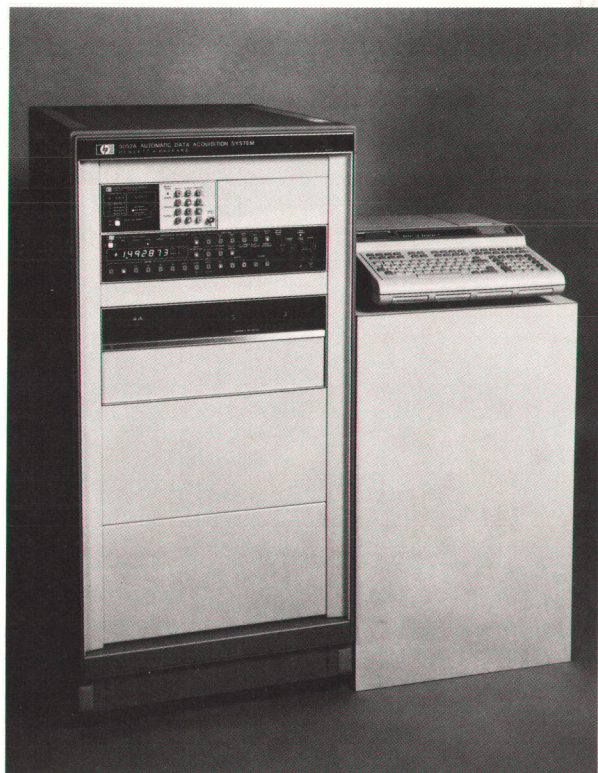

The Model 9825A Calculator brings to this system many capabilities formerly found only in computer-based systems, from transducer linearization to statistical analysis. It uses a high-level, formula-oriented programming language (HPL) designed for controller applications as well as for data processing. The user communicates with the calculator by way of the typewriter-like keyboard and the calculator responds with its alphanumeric display and printer, giving immediate feedback on errors from improper syntax.

Manuals supplied with the system give complete details on starting up the system and programming it. Also included are pre-recorded tapes that have subroutines for operating the instruments, thermocouple linearization routines, data plotting routines, and a number of application routines that are modular in structure, allowing the user to modify them easily for his particular applications. Among the application routines is one for analysis of waveforms sampled by the Model 3437A Voltmeter. It uses a Fourier algorithm for identifying and measuring harmonics as small as 60-dB below the fundamental, besides giving waveform amplitude and frequency. The print-out reproduced here shows an analysis of a triangular wave (the print-out was made on the optional Model 9871A Impact Printer).

The system is interconnected by the HP interface bus, allowing easy expansion with other instruments, such as signal sources, counters, and power supplies and other peripherals like X-Y plotters and digital clocks. It is fully integrated, tested, verified and specified as a system prior to shipment, enabling it to go to work as soon as it is installed.

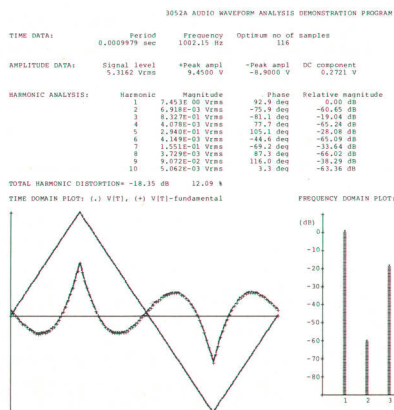

then addresses the voltmeter to "talk" and itself to "listen" so the voltmeter readings can be sent to the calculator. The time taken by the calculator for the readdressing is almost one millisecond, however, so the first three readings are lost. If the voltmeter had been sent a T1 (INTERNAL) code instead of T3, it would not have started to take readings until readdressing was complete and the ATN line went false.

Output Format

Voltmeter readings can be supplied to the interface bus in either of two formats. The normal format is ASCII, in which each character is presented in one byte as a single ASCII character. Each reading requires seven bytes in fixed-point notation, compatible with most free-field FORTRAN formatters.

If high reading rates are needed, readings can be transferred in two bytes using the PACKED format. The PACKED format, however, does require that the user write a special program for unpacking the data. The ASCII format, though simpler to use, needs time to handshake seven bytes plus the digitizing time, thus restricting the overall reading rate significantly.

The PACKED format also reduces memory requirements for storage of data in the system controller.

Alert to Special Conditions

Special conditions needing the attention of the system controller often arise in voltmeter applications. Three conditions can cause the Model 3437A to pull the interface SRQ service request line true. The voltmeter can be programmed so that any combination of these three conditions (or none at all) will activate the SRQ line.

The first of these is DATA READY. Normally, the system controller triggers the voltmeter, then readdresses itself and the voltmeter to accept the reading. Certain output sequences, however, may keep the interface bus tied up for a long time waiting for the reading, preventing other devices from using the bus (the longest sequence, using DELAY = 0.9999999 seconds and NUM READINGS = 9999, is more than 2 hours and 45 minutes). With DATA READY programmed to pull the SRQ line, the system can be programmed so the voltmeter uses the bus only when it transfers a reading.

IGNOR TRIG is programmed to pull SRQ if a missed trigger is significant, such as when digitizing a transient. At other times, as when operating in the "sampling oscilloscope" mode (Fig. 6), ignored triggers could be expected to occur. The voltmeter would then be programmed so the IGNOR TRIG status would not affect the SRQ line.

The INVALID PGM status occurs when the voltmeter is given commands it cannot recognize. This is used to pull the SRQ line primarily as a help during de-

bugging procedures.

The voltmeter is programmed to respond to any combination of these three conditions by the entering of a number after the ENAB RQS* key is pressed (or programmed). The number is derived by adding the code numbers for the special conditions given on the front panel, e.g., entering the number 3 causes RQS to be activated if either an invalid trigger (2) occurs or an invalid program command (1) is received. All of the RQS information is included in the byte sent in response to a serial poll.

What's Inside

A simplified block diagram of the Model 3437A System Voltmeter is shown in Fig. 7. The entire analog section is inside a guard, permitting floating measurements up to ± 42 volts off ground. Control signals and data are coupled to and from the digital section outside the guard by optical and transformer isolators.

The input attenuator introduces 20 dB of attenuation on the 10V range only. Otherwise, the signal input goes directly to the autozero switch and then to the input amplifier.

The input amplifier gives a gain of 2 on the 1V and 10V ranges. On the 0.1V range, the feedback network is switched to give a gain of 20 and system bandwidth is reduced from about 1 MHz to 40 kHz to reduce the effects of noise on low-level signal measurements.

The sample-and-hold switch follows the amplifier. Normally it is closed so the voltage on the sampling capacitor tracks the input voltage. When a measurement is initiated, the sample-and-hold switch opens, holding the most recent voltage level on the capacitor. At the same time, the autozero switch connects the amplifier input to ground so the amplifier offset can be applied to the analog-to-digital converter to null out the offset that appears with the signal on the sampling capacitor.

The output of the analog-to-digital converter goes in serial-BCD format to the microprocessor, which formats the data for the display. It also formats the data for the interface bus in either the byte-serial ASCII or packed formats.

Digital Design

The microprocessor that controls the voltmeter operation is the same control-oriented, parallel processor used in the Model 3455A Digital Voltmeter. It was chosen because of its speed, which makes the voltmeter's high reading rate possible. The microprocessor handles both the measurement cycle and the interface, being able to do both jobs because very little arithmetic is done.

*RQS is the abbreviation for the information sent to a system controller in response to a system poll.
SRQ is the abbreviation for the interface bus line that causes the controller to initiate a poll whenever that line goes true.

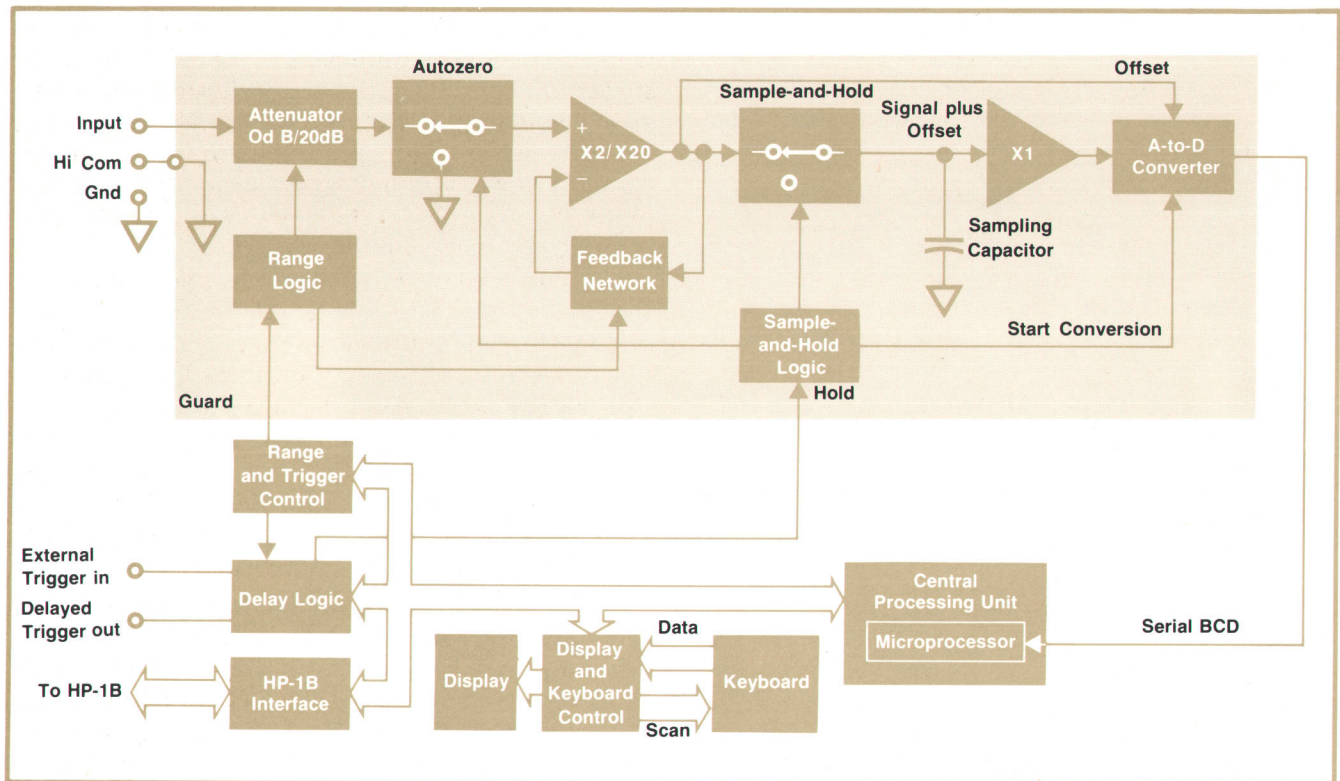

Fig. 7. Simplified block diagram of Model 3437A System Voltmeter.

To minimize hardware costs, it was desired to bring as many tasks as possible inside the microprocessor. Certain tasks, however, such as scanning the display, place an undue burden on a microprocessor. It was therefore decided to implement display scanning and the trigger delay in hardware while all remaining tasks are handled within the microprocessor.

To maximize processor availability, a single-level priority-interrupt scheme was devised. It is structured so the interrupt system is engaged for no more than 100 μ s at a time. With only one interrupt level, this guarantees a maximum response time of 100 μ s to the highest priority interrupt. By using the interrupt system, the processor is relieved of the time-consuming task of polling various interrupts to determine the next task.

A mainline program runs whenever there are no interrupts awaiting service. The mainline program scans the keyboard, interprets entries, and carries through with the command task. Provision has been made in both hardware and firmware to assure that the mainline program is never locked out by recurring interrupts (when outputting readings at its maximum rate, the voltmeter processes about 30,000 interrupts per second).

As mentioned previously, the scanned display was implemented in hardware. The voltmeter's front panel has 14 LED digits (7 segments each), and 21 individual LED annunciators that show the current

program states. Data for the display is put into a pair of 4×16 RAMs and scanned out to the LED digits and annunciators. The microprocessor reads or writes this memory the same as an I/O port but does not have to update it continuously, changing data only when necessary.

Interpolated Delay

As discussed previously, the voltmeter can generate a delayed trigger, programmable in 100-ns steps, up to one second after the actual input trigger. To insure accuracy and stability, digital delay is used. Trigger generation is completely asynchronous to the 10-MHz clock, however, because of an analog interpolator. Without the interpolator, the delayed trigger would have a timing uncertainty of 100 ns.

Operation of the delay interpolator is illustrated in Fig. 8. The occurrence of an external trigger sets a flip-flop that starts a capacitor charging towards a reference voltage. Normally, the capacitor voltage would reach the reference in 100 ns, but the first clock to occur after the trigger causes the charging current to be interrupted, holding the charge on the capacitor.

The charge is held until digital counters count down the desired number of 100-ns increments minus one. Capacitor charging then resumes until the voltage reaches the reference level, at which time the delayed trigger is generated. This technique enables delayed triggers to be generated asynchronously and repetitively with less than 10-ns jitter.

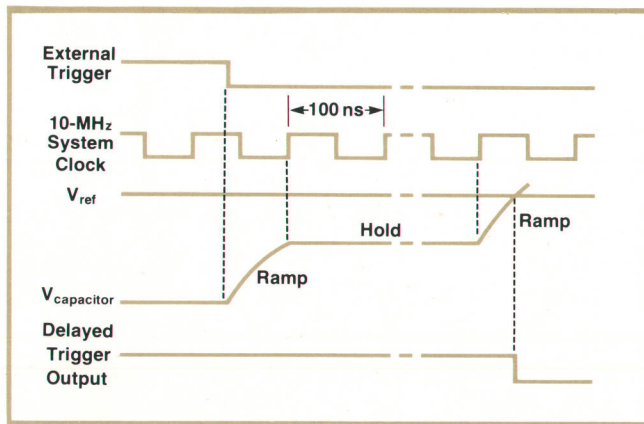

Fig. 8. Operation of the trigger delay interpolator. The external trigger may occur at any time with respect to a clock edge, and the delayed trigger will be generated with less than 10-ns timing uncertainty.

Minimum Down Time

Model 3437A was designed to minimize the time that a system would be out of service because of voltmeter maintenance. The zener diode used for the reference voltage, for example, has a typical drift of 3 ppm/month, far below that which would affect the voltmeter's readings. Because of this stability, no trimmers are provided (or needed) for the reference voltage. Instead, during final test, padding resistors are selected by the computerized test system and installed permanently. The digital-to-analog converter uses a fine-line, thin-film resistor set that is matched within 0.01% (see article following), hence, it needs no trimmers either. In fact, the instrument has only two trimming adjustments: a variable capacitor for adjusting the input transient response, and a variable resistor that compensates for production tolerances in the offset of the analog-to-digital converter. Both of these can be adjusted in less than 10 minutes using internal test circuits, eliminating the need for a trip to the calibration lab.

The digital-to-analog converter is an example of the kind of no-trimmer design techniques used. This converter uses the traditional successive-approximation algorithm: at the start of a conversion, a value equivalent to one-half of full scale is compared to the unknown input. If the input is less than this value, the value is switched out and a second, smaller value switched in for comparison. If the input is greater than one-half full-scale, the first value is retained when the second value is switched in. Again, a comparison is made and the second value is kept or rejected according to the result. This process repeats with smaller and smaller values until the limit of the voltmeter's resolution is reached. The state of the switches that insert or reject values thus corresponds to the input voltage.

In the Model 3437, the digital-to-analog converter

works with an offset so the unipolar converter can work with bipolar inputs. A value of zero in the successive-approximation register corresponds to the most negative full-scale input (e.g. -1.998V), full value corresponds to a full-scale positive input voltage ($+1.998\text{V}$) and half value corresponds to zero input. The first value in the successive-approximation algorithm is thus an indicator of polarity.

A skeleton diagram of the converter is shown in Fig. 9. The comparator responds to the sum of the currents flowing into the summing node at its negative input. A fixed current flows into this node from the positive reference, $+V_{\text{ref}}$. One of the other two currents results from the unknown input voltage and the other flows from the minus reference voltage, $-V_{\text{ref}}$, through whatever bit-weighting resistors are switched to $-V_{\text{ref}}$. When the three currents sum to zero, the summing node is at ground.

At the start of a conversion, resistor X1 is switched to $-V_{\text{ref}}$. If the summing node is then above ground, the comparator indicates to the logic circuit that X1 should remain connected when X2 is switched to $-V_{\text{ref}}$ on the next clock pulse. If the summing node had been below ground, X1 would have been disconnected at the time X2 was switched in. On each succeeding clock pulse, the next resistor is switched in and retained or rejected on the following clock pulse according to the result of the comparison. The total current into the summing node thus approaches zero as the conversion proceeds (the input amplifier offset is applied to the positive input of the comparator, rather than ground as shown here, to compensate the reading for the offset).

X1, equivalent to 2000 counts in the display, is the polarity indicator, being off for negative input voltages and on for positive inputs. X2, equivalent to 1000 counts, corresponds to the most significant digit (1 or 0) and the next four resistors, weighted 800, 400, 200, and 100, correspond to the next most significant digit. Similarly, the remaining resistors are weighted 80, 40, 20, and 10, and 8, 4, 2, and 1 to give the $3\frac{1}{2}$ digit reading in BCD format. For positive input voltages, which give output values greater than 2000, the microprocessor subtracts 2000 counts to obtain the value for display. For negative input voltages, where X1 would be off, the microprocessor subtracts the A-to-D output from 1999 and inserts the negative sign for the display.

Switching of the resistors is performed by CMOS digital inverters with six matched inverters on a single chip. The source voltage for the inverters is supplied by amplifier A1 which, by means of its operational amplifier configuration, also establishes the negative reference, $-V_{\text{ref}}$, precisely equal in magnitude to $+V_{\text{ref}}$. The feedback path includes the output resistance R_{out} , of one of the inverters so the out-

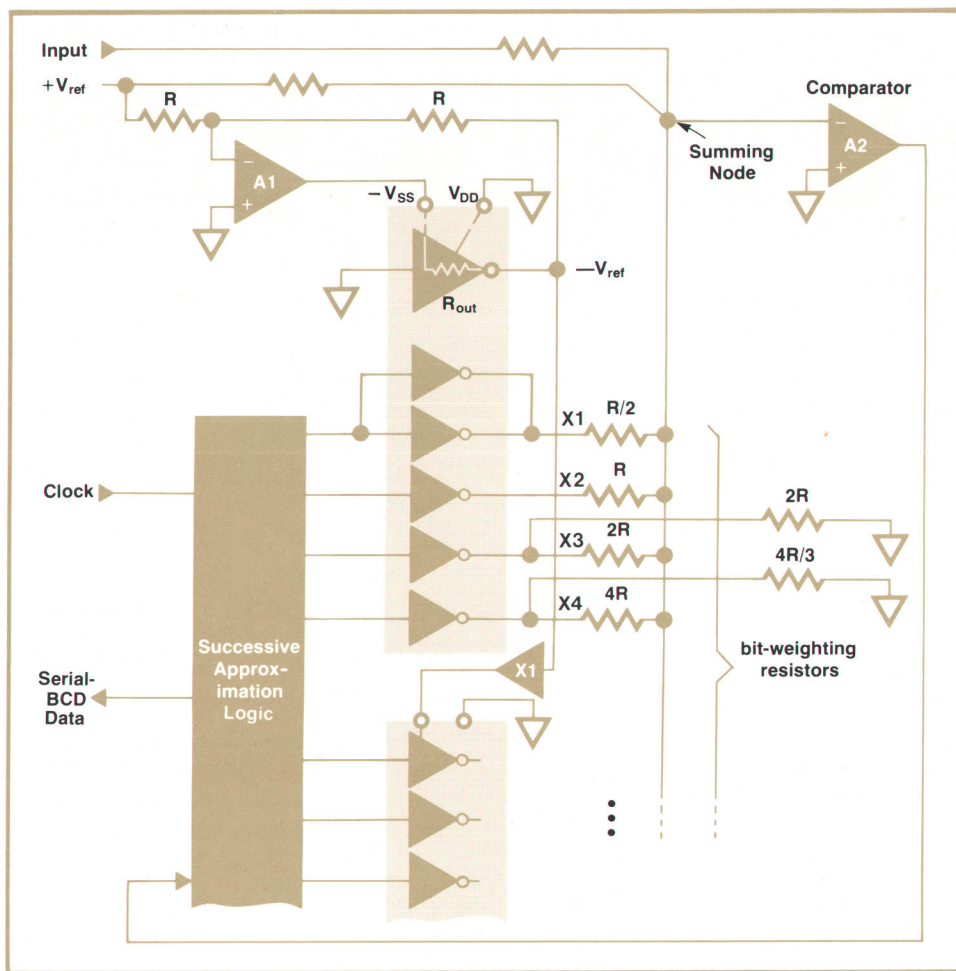

Fig. 9. Switching arrangement for part of the analog-to-digital converter. There are actually 14 bit-weighting resistors to give a $3\frac{1}{2}$ -digit reading in BCD format with polarity sign.

put of any of the inverters, when switched to the low state, is at $-V_{ref}$.

The advantage of this design is that when the output of an inverter is high (ground level), there is no current in its associated resistance because the input to the comparator, when balanced, is also at ground level. Hence, the inverter output resistance, which in the high state is about five times greater than in the low state, has no effect on the measurement.

When in the low state, each inverter has an effective output resistance of $\pm 4\Omega$ worst case because of the feedback in amplifier A1 (inverter output resistances are matched within 10%). With R equal to $50k\Omega$, the maximum possible error in the second data bit is then only 0.08 digit and the errors in succeeding inverters are negligible because of the lower currents encountered (the first bit, and several other parameters, are calibrated by the adjustment of V_{ref} during production test). Hence, the bit-weighting resistors need no compensating adjustments.

Minimum Power Consumption

Power consumption was reduced whenever possible to achieve cooler operation and thus enhance reliability. Because of this approach, a discrete series

regulator was chosen for the power supply rather than one of the popular integrated circuit regulators. This enabled the regulator to be designed for minimum power dissipation with the particular load that the voltmeter circuits present to it. Higher efficiency is obtained by using a high-current PNP transistor as the regulator. It functions when run into saturation, where there may be as little as 300 mV between input and output. In addition, at maximum current only 50 mV appears across the series current-sense resistor (actually a 100-nH inductor). The power saved is substantial, as shown in the following table.

Power Supply Comparison

Power requirements: $5V \pm 5\%$; $I=2A @ 4.75V$, $2.22A @ 5.25V$.
Input voltage tolerance (line): nominally $+7\%$, -13% .

	3437A Supply	IC-regulator Supply
Maximum regulator input current (includes base current):	2.04A	2.24A
Minimum regulator input voltage (dropout):	5.1V	7.3V
Typical time-average input voltage:	7.35V	10–12.15V
Maximum regulator dissipation	6W	11.6–14.9W
Typical power consumption:	15W	22.4–27.1W
Maximum consumption:	18.2W	27.1–32.6W

3437A transformer efficiency: 90%; winding tolerance: $\pm 3\%$. Rectifier forward voltage tolerance: 0.25V.

Acknowledgments

Much helpful advice was provided by Section

Manager Jerry Nelson. Mechanical design was by Lee Smith. 

John E. McDermid

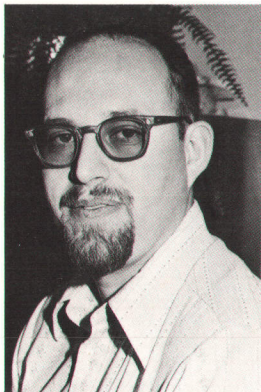

John McDermid earned his BSEE degree at the University of Idaho and, on obtaining a fellowship, moved to the University of Alberta at Calgary, Canada, where he obtained an MSEE degree (1969). He then joined HP's Loveland Division, initially investigating high-speed A-to-D converters and then designing the dc portions of the Model 3490A Digital Voltmeter. He subsequently became project manager for the 3437A Voltmeter. John says he's become addicted to fishing and hunting with a bow

and arrow and the whole family (wife, son 8 and daughter 4) join him for those expeditions, going along in their travel trailer.

James B. Vyduna

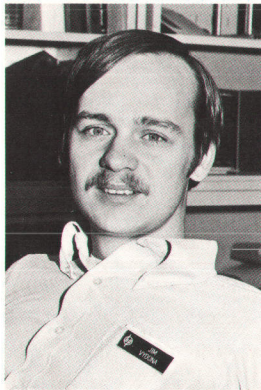

Jim Vyduna started with HP in 1973 as a production engineer after getting his BSEE degree from the University of Illinois. Six months later he switched to the Loveland Division's R and D lab where he worked on some exploratory projects before taking on the digital portions of the 3437A Voltmeter. Jim has a one-fourth interest in an airplane that he flies, when it's his turn, and also helps to maintain. In addition, he sings tenor in a quartet made up of HP engineers and he and his wife are

also active in church-sponsored youth groups. As if all that weren't enough, he contributed the wiring, painting, and other tasks to a new home he had built.

Joseph M. Gorin

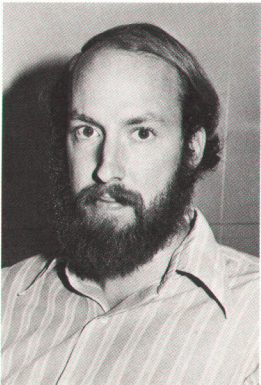

Originally from Pittsburgh, Pennsylvania, Joe Gorin attended the Massachusetts Institute of Technology where he earned both BSEE and MSEE degrees. While there on a research assistantship, he designed a satellite experiment for measuring electrons and protons in the solar wind that is now in orbit in SOLRAN HI. Joining HP in 1974, he worked on some investigative projects before tackling the analog section (including the power supply) of the 3437A voltmeter. Joe plays on the championship HP R and D volleyball team and he does some skiing. He is also an ardent hiker, taking a four-month leave of absence following completion of the 3437A design to travel with his wife to various parts of the country and explore them on foot.

SPECIFICATIONS

HP Model 3437A System Voltmeter

RANGES

Ranges	Max. Display
10V dc	±19.98
1V dc	±1.998
0.1V dc	±1.998

RANGING: Manual or Remote

STATIC ACCURACY (90 days, 23°C ±5°C):

10V RANGE: ±0.05% of reading ±1.6 digits

1V RANGE: ±0.03% of reading ±1.6 digits

0.1V RANGE: ±0.06% of reading ±1.8 digits

TEMPERATURE COEFFICIENT (0°C—50°C):

±0.002% of reading/°C ±0.05 digits/°C

INPUT BANDWIDTH (3 dB)

10V RANGE: 1.0 MHz

1V RANGE: 1.1 MHz

0.1V RANGE: 40 kHz

SETTLING TIME

10V RANGE, with 10V step input: Reading settles to within 30 mV of final value in 7.5 μs or to within 200 mV of final value in 700 ns.

1V RANGE, with 1V step input: Reading settles to within 3 mV of final value in 1.5 μs or to within 20 mV of final value in 700 ns.

0.1V RANGE, with .1V step input: Reading settles to within 200 μV of final value in 25 μs.

COMMON MODE REJECTION (CMR) (with 1kΩ unbalance in low lead at dc to 60 Hz): >75 dB. (CMR is the ratio of the peak common-mode voltage to resultant peak error voltage in the reading).

INPUT CHARACTERISTICS (triaxial input with front and rear inputs in parallel):

INPUT IMPEDANCE:

10V RANGE: R=1MΩ±20% shunted by <75 pF.

1V RANGE: R>10⁸Ω±20% shunted by <75 pF.

0.1V RANGE: R>10⁸Ω±20% shunted by <75 pF.

MAXIMUM INPUT VOLTAGE, HIGH TO LOW (on all ranges):

<±30 V Peak.

MAXIMUM VOLTAGE LOW TO CHASSIS: ±42 V Peak

NUMBER OF READINGS (N RDGS): 0 to 9,999. When N=0, 3437A operates in delay mode only.

MAXIMUM READING RATE (REMOTE AND N RDGS>1):

ASCII: $\frac{3,600}{3,600 + \text{listen rate}^1}$

Packed: $\frac{5,700}{5,700 + \text{listen rate}^2}$

¹Listen rate is maximum speed (minimum delay) that listener can accept 7 data bytes.

²Listen rate is maximum speed (minimum delay) that listener can accept 2 data bytes.

DELAY

N RDGS=0 OR 1: 0 to .9999999 s in 0.1-μs steps.

N RDGS>1 (REMOTE): Minimum to 0.9999999 s in 0.1-μs steps.

Minimum delay is a function of listener delay related by:

ASCII: 277.8 μs + listener delay.

Packed: 175.4 μs + listener delay.

ACCURACY (Ext. trig to DELAY out, 0°C to 50°C):

DELAY OFFSET: 100 ns ± 25 ns (with <150 pF cable capacitance).

DELAY ACCURACY: ±0.008% DELAY setting + delay offset.

DELAY REPEATABILITY (JITTER) FOR N RDGS = 0 or 1:

DELAY OF 0 OR .1 μs: ± 2 ns.

DELAY OF .2 μs TO 50 ms: ±10 ns + 0.0002% DELAY setting

DELAY OF GREATER THAN 50 ms: ±110 ns

DELAY OUTPUT: Low true TTL.

EXTERNAL TRIGGER: Low true TTL edge trigger.

OPERATING TEMPERATURE: 0 to 55°C.

HUMIDITY RANGE: <95% R.H., 0 to 40°C.

POWER: 100V, 120V, 220V, 240V + 5%, -10%. 48 Hz to 440 Hz line operation. Less than 42VA.

DIMENSIONS: 212.7 mm wide × 88.9 mm high × 527.1 mm deep (8-3/8 × 3½ × 20¾ inches)

WEIGHT: 5.6 kg (12 lbs., 4 oz.)

PRICE IN U.S.A.: \$1900.

MANUFACTURING DIVISION: LOVELAND INSTRUMENT DIVISION 815 Fourteenth Street, S.W. Loveland, Colorado 80537 U.S.A.

Contemporary Design Practice in General-Purpose Digital Multimeters

With lower cost and smaller size, digital multimeters are now found in a very broad range of applications. New approaches to design are required to meet the demands posed by this universality.

by Roy D. Barker, Virgil L. Laing, Joe E. Marriott, and H. Mac Juneau

DIGITAL MULTIMETERS are now more reliable, smaller, and lighter than they were a few years ago, and they perform better at less cost. Consequently, these versatile instruments are finding their way into the hands of a much broader range of users, necessitating new approaches on the part of the designers.

Although circuit design innovations and advances in semiconductor technology have contributed many changes, a better understanding of customer use—and accidental misuse—has created a need for more thorough design evaluations. The product assurance effort at HP's Loveland Instrument Division, for example, is now about evenly split between potential-problem analysis and conventional reliability engineering, such as component selection, instrument and component life testing, and failure analysis.

The goal of potential-problem analysis is to predict the possibilities of user errors or misapplication—now that the new, smaller, lighter, low-cost instruments are found in circumstances much less protective of their well-being—and to verify that new instrument designs are immune from damage resulting from most of these possible misuses. Verification is obtained by subjecting new designs to a rigorous set of abuse tests.

Digital multimeters (DMMs) are particularly appropriate for abuse testing because they are often exposed to situations involving voltage and power levels that are quite high. New multimeters being designed at the Loveland Instrument Division now must survive 230V ac into any terminal pair on every function and range setting, massive current overloads into the current measuring terminals, and 1000 volts dc (with a 50-mA current limit) into any terminal pair with disallowed function or range settings (one insidious way of obtaining disallowed function or range conditions is to push more than one pushbutton, such as ohms and volts, at the same time). They must also survive a 15-kV static discharge that simu-

lates the arc occurring when a person touches a metallic object after walking across a carpet on a dry day.

The series of abuse tests is applied to prototype instruments and the results communicated to the design engineers, who modify the design accordingly. Out of this interchange, certain design principles have emerged. For one, grounded traces are placed in close proximity to the input and displays so any static discharge will be drawn to ground before it would be attracted to a vulnerable circuit component. Fuses in series with the input circuits are used liberally (Fig. 1). The ohms input not only has a fuse, but also a series resistance and limiting diodes to minimize damage from an attempt to measure voltage while the instrument is in the ohms mode. The amperes input is now separated from the volt-ohms input to reduce the likelihood that a voltage measurement would be attempted while a low-impedance current shunt is in the circuit. The logic for the front-panel switching is designed so that if two buttons are pressed, the in-

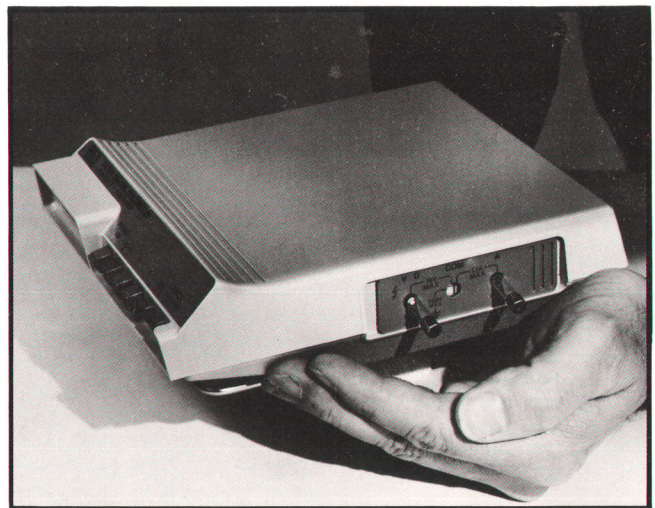

Fig. 1. Both inputs to the Model 3476A Digital Multimeter located on the side of the instrument, are fused. Sliding the small panel to the right aligns the input holes with the fuses, making them readily accessible for replacement.

An Economical 3½-Digit Multimeter

Model 3476A, Hewlett-Packard's lowest priced digital multimeter, is a 3½-digit instrument that measures dc and ac volts, dc and ac current, and resistance. It has autoranging and autopolarity selection but it also has a range-hold function that retains a range regardless of input changes. Full-scale ranges are from $\pm 0.110\text{V}$ to $\pm 1000\text{V}$ dc and ac, ± 0.110 and ± 1.10 A dc and ac, and $1.10\text{ k}\Omega$ to $11,000\text{ k}\Omega$. Mid-range dc accuracy is $\pm(0.3\%$ of reading + 1 digit). The frequency range for ac voltage and current measurements is 45 Hz to 5 kHz.

The most striking feature of this compact instrument is its unorthodox shape, a shape that evolved from human factor considerations. The thin, flat enclosure allows the instrument to be carried conveniently in a brief case or in a tool box. The upward slope on the forward edge of the top surface provides a convenient finger rest to prevent the instrument from sliding away when the pushbuttons are pressed. It also provides a handy grip for picking up the instrument. The "roof" over the display shields the LED display from direct light, enhancing its readability. The rim running below and up at each end of the row of pushbuttons protects the buttons from impact should the instrument be dropped accidentally.

Hewlett-Packard already offers an autoranging 3½-digit multimeter, the hand-held Model 970A Probe Multimeter (Hewlett-Packard Journal, November 1973). The design goal for the new Model 3476A was to get improved performance at lower cost by eliminating the circuit restraints imposed by the small size of the probe multimeter. Consequently, Model 3476A uses discrete components on a wave-soldered printed-circuit board rather than the hybrid circuit used in the probe multimeter. This reduced production costs below those incurred by the wire-bonded hybrid circuit. Even the power transformer is wave-soldered into the instrument during the single soldering operation. However, to assure that high impedance is maintained at the input under all normally encountered environmental conditions, Teflon insulated wire and Teflon cloverleaf insulators are used, and this entails some hand wiring.

On the other hand, the monolithic digital integrated circuit

developed for the Model 970A Probe Multimeter is used in the Model 3476A because it reduces the large number of interconnections and parts that any digital multimeter needs. This integrated circuit includes counters, buffer storage, code conversion for the display, display scanner, autorange circuits, several ROMs, and most of the analog switching. It was modified for the 3476A application to include the range-hold function.

Costs were reduced further by use of the fine-line, thin-film resistor pack (see main article) that was not available at the time of the probe multimeter's development. The instrument's readout is a newly developed monolithic LED display similar to but larger than the LED displays used in the probe multimeter and also in HP hand-held calculators. It displays measured values directly in volts, kilohms, or amperes.

One version of the new multimeter is designed for ac line operation only (Model 3476A) and another version operates from internal NiCad batteries (Model 3476B). The battery-powered version operates up to eight hours on one battery charge and recharges overnight.

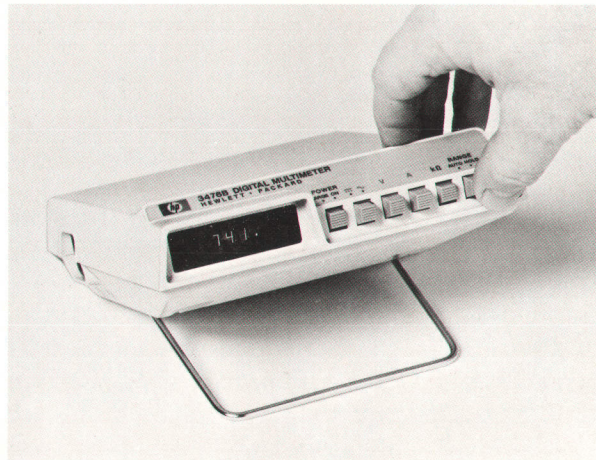

strument will go to the least vulnerable mode, usually the volts mode.

As a result, the new generation of DMMs is considerably tougher and more forgiving of accidental abuse than earlier generations.

Integrating the Attenuator

Advances in technology continue to improve the price/performance ratio achieved with new multimeter designs. One area that until recently had not benefited from new technology is the precision attenuator that ultimately determines a multimeter's accuracy. Historically, DMMs have used discrete wirewound resistors. Some use has been made of laser-trimmed thin-film and thick-film resistors, but these have usually been limited to values below one megohm if stable materials are used. One way around this limitation is found in the Model 970A Probe Multimeter which has low-cost discrete resistors of 1% accuracy in series with thin-film resistors; the thin-film resis-

tors are trimmed to establish the accuracy of the series combinations.

Using thin-film resistors exclusively would reduce costs by eliminating several discrete components and the handling and soldering they entail. Tantalum nitride is a preferred material for a thin-film resistor because it has controllable temperature response, lends itself readily to vacuum deposition techniques, and the finished product is stable and durable. The drawback is that a thin deposition of tantalum nitride has a maximum resistance of 100Ω per square, giving a practical maximum limit of about $60\text{ k}\Omega$ using conventional thin-film techniques.

This has now been changed by application of state-of-the-art photomasking and other semiconductor processing techniques to the fabrication of tantalum-nitride resistors. Thin-film resistors can now be made with a line width of only 5 microns thus making it practical to obtain resistance values as high as $10\text{ M}\Omega$. A $10\text{-M}\Omega$ resistor 5 microns wide turns out

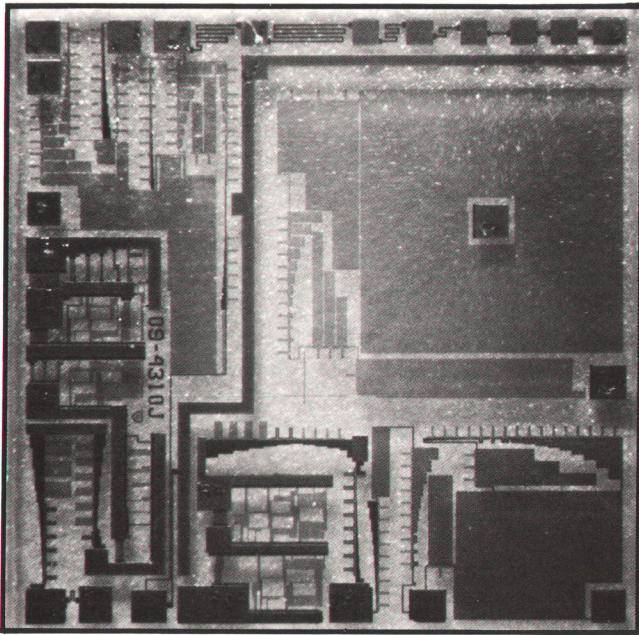

Fig. 2. Fine-line resistor set used in the Model 3465A Digital Multimeter is on a substrate measuring 4.5×4.5 mm. The square area in the upper right is a 10-MΩ resistor in a square spiral pattern. With a 5-micron line width and 5-micron spacing, the lines are indistinguishable in this photo.

to be 500 millimeters long but when deposited with only 5-micron spacing between lines, it can be contained in a square less than 2.5 mm on a side.

With this technique, all of the resistors needed for a digital multimeter can be deposited on one sapphire substrate (Fig. 2). This close-packed arrangement assures that the resistance values track closely with changes in temperature, maintaining constant resistance ratios for more accurate performance. It also reduces space requirements. If implemented with discrete resistors, the same resistor set would require four square inches (2500 mm²) of printed circuit board.

The final leg of each thin-film resistor has a series of parallel shorting links that cause the total resistance to be lower than the desired value. These are opened

selectively by a laser beam under computer control, effectively adding lengths of resistor to the total. Once an index mark on the substrate is located, a computer controls the X-Y positioning of the substrate according to the measured value of the resistor, moving the appropriate link under the laser beam for dissolution. In this way, each resistor is brought up to the desired value and the resistance ratios for each set of resistors can be trimmed to an accuracy of better than 50 parts per million.

Not only does this technique achieve good accuracy but it also lowers production costs by reducing the time needed for calibrating the finished instrument. It is a major contributor towards reducing the costs of the new HP DMM's while improving performance and reliability.

Rethinking the Circuits

The basic block diagram of a DMM hasn't changed (see Fig. 3), but advances in semiconductor technology require repartitioning of the functions to take advantage of large-scale integrated-circuit technology without sacrificing performance. For example, an autoranging multimeter with a dual-slope analog-to-digital converter requires a large number of switches for analog signals. Since the switches are controlled by MOS control logic in a large-scale integrated circuit, it would be expedient to use MOS transistors as those switches.

MOS transistors, however, cannot directly replace mechanical switches because of resistance and voltage limitations. For one, MOS switches having ON resistances less than 100 ohms are too large to be practical and economical in a conventional circuit configuration. For another, the substrate on which all the logic and MOS switches are fabricated behaves as a "back-side" gate, so the source-to-substrate voltage of each switch modulates the switch's ON resistance. This "back-gate" bias effect thus constrains the use of MOS transistors as switches to applications where the source voltage is at or near circuit ground.

This suggests the use of an operational amplifier for

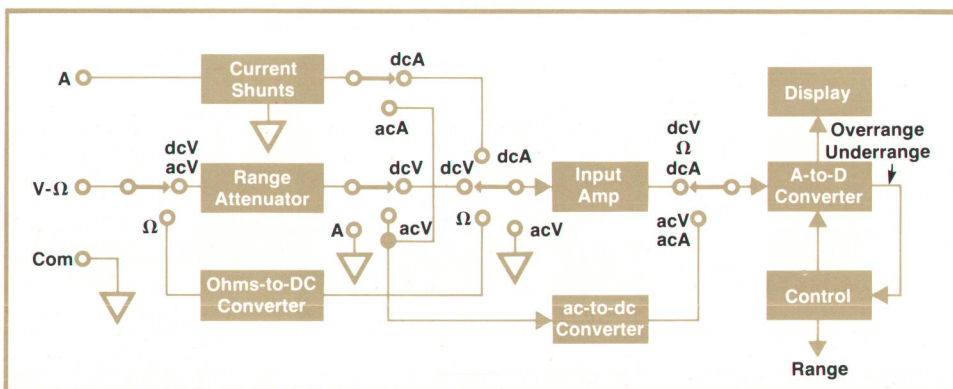

Fig. 3. Generalized block diagram of a digital multimeter. Individual instruments may differ in details.

A Precision 3½ Digit Multimeter

Model 3435A Digital Multimeter is a 3½ digit instrument that has better accuracy (0.1%) than Model 3476A, a wider frequency range for ac signals (to 100 kHz), and higher sensitivity for resistance measurements (10-mΩ resolution). It measures dc and ac volts with full-scale ranges from 200mV to 1200V, resistance from 20Ω full-scale to 20 MΩ, and dc and ac current ranging from 200 μA full-scale to 2000 mA, with automatic polarity indication and either manual or automatic range selection (except when measuring current). Lighted front-panel annunciators show the function and range selected.

An optional "touch-hold" probe enables a voltage reading to be retained on display when a pushbutton switch on the probe body is pressed. This facilitates measurements in situations where it may be difficult to hold the probe in position while looking away to read the measurement.

Pressing the button on the probe grounds the amperes input, which is converted to a logic input whenever the instrument is switched to either the dc or ac volts mode. Grounding the amperes input interrupts the voltmeter's logic circuits so voltage sampling is stopped and the most recent reading is retained on

display. Releasing the button restores normal operation.

Model 3435A is powered by a sealed lead-acid storage battery that can give more than 10 hours of continuous operation with only 12 hours recharge (a built-in charger is included). With a new high-efficiency LED display, the voltmeter dissipates only three watts, not only extending battery life, but also enhancing accuracy, stability, and reliability by keeping internal temperatures low.

Model 3435A uses the fine-line resistors and the single-reference A-to-D converter described in the accompanying article, giving it high-grade performance at low cost. Servicing and calibration costs are also low because there are only four potentiometers and two capacitors that require adjustment during routine calibration procedures.

The instrument is housed in a tough plastic case, well suited for applications requiring portability. The carrying handle doubles as a bail, being able to rotate through 15 positions, each secured by a positive locking detent. An optional version (Opt. 002) is in a modular cabinet that can be racked or stacked with other HP modular instruments (see photo below).

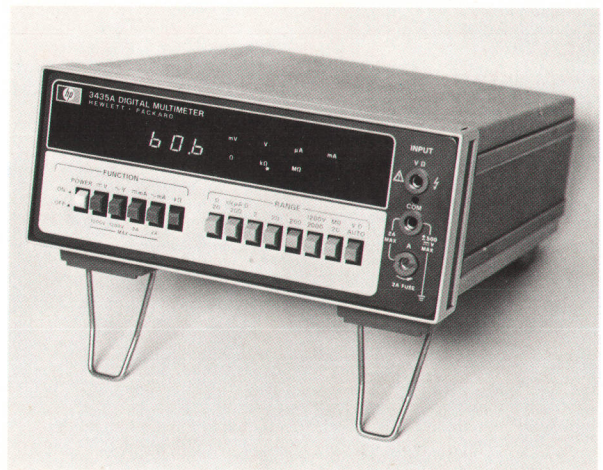
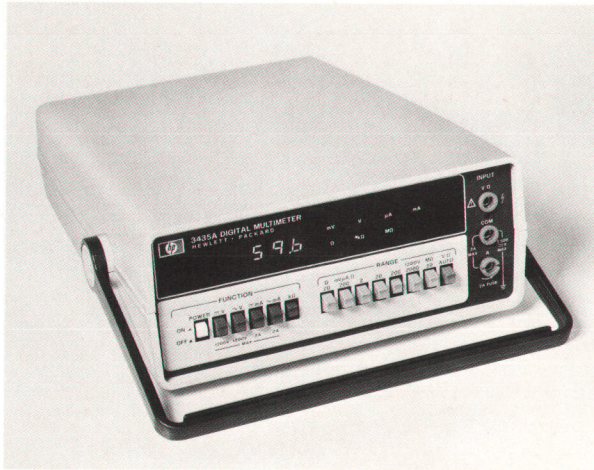

an attenuator, using a switched feedback network for the various ranges as shown in Fig. 4a. The operational amplifier establishes a virtual ground at the summing point at its inverting input where the switches are. The problem with MOS transistor back-gate bias is thus eliminated. The problem with the ON resistance remains, however. The ON resistance in series with the 1-kΩ resistor of Fig. 4a must satisfy the following relationship if it is to introduce less than a one-count error in a full-scale reading in a 2000-count (3½-digit) voltmeter:

$$R_{ON} \leq \frac{1000\Omega}{2000} = 0.5\Omega$$

This is a value much lower than that realizable at the present time.

The effect of the MOS transistor ON resistance can be reduced significantly by shifting the summing

point to the other side of the MOS switches and then using additional MOS switches to connect the appropriate summing point to the amplifier's inverting input, as shown in Fig. 4b. The ON resistance of a MOS switch in series with the 10-MΩ input resistance easily satisfies the relationship (for a 1-count error in a 2000-count voltmeter):

$$R_{ON} \leq \frac{10 \times 10^6 \Omega}{2000} = 5000\Omega$$

The switches between the summing points and the amplifier's inverting input contribute negligible errors because very little current flows through them.

To prevent errors from source-to-substrate leakage currents in the OFF switches, the MOS switch fabrication process must be carefully controlled. A 200-mV input to the attenuator of Fig. 4 results in a mere 20 nA flowing through the 10-MΩ resistor. This corresponds to 10 pA per count in a 2000-count volt-

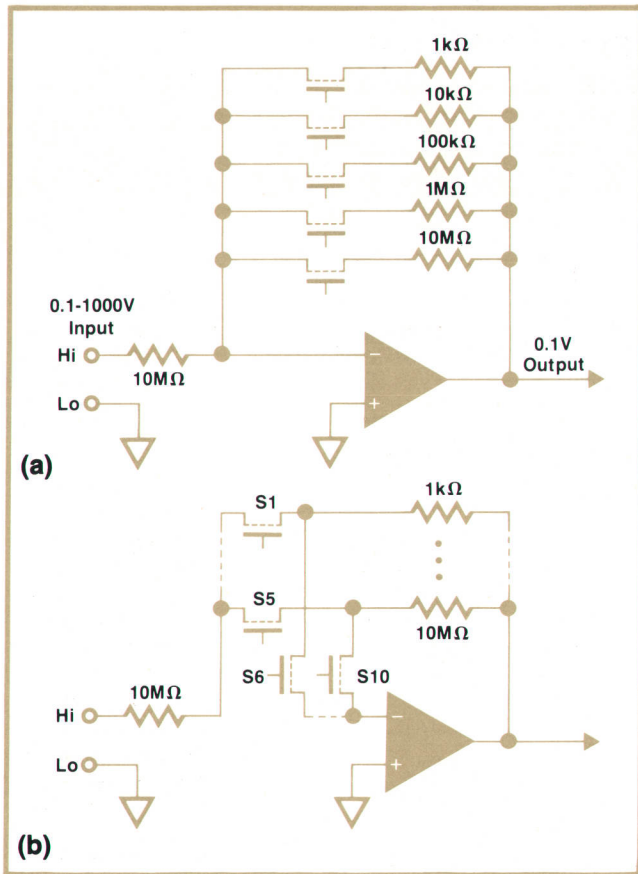

Fig. 4. (a) Range-switching arrangement. (b) Modification that reduces effect of MOS-transistor "on" resistance. Here, S1 and S6 are switched on to select one range, S2 and S7 (not shown) select another, and so on to S5 and S10.

meter. Thus, the sum of all leakage currents must be less than 10 pA to avoid errors from this source.

Lower-Cost Circuits

New ideas in circuit design continue to reduce the number and precision of parts used in multimeters. An example is the dual-slope A-to-D converter widely used in digital multimeters. A simplified diagram of one such converter is shown in Fig. 5. If R1 and S2 were removed from this diagram, the result would be an autozeroed single-polarity ($V_{in} \leq 0$) converter of traditional design.

The conversion cycle starts in autozero with S1 to ground and the voltage building up on C2 causing the current flow through C1 to go to zero. The resulting voltage on C1 is the difference between the integrator and comparator offset.

Next, S4 opens with C2 holding the zeroing voltage and S1 connects to the input voltage. Integrator capacitor C1 now charges for a fixed time established by the control circuit. Then, S1 switches to ground, S3 closes, and C1 discharges until it reaches the autozero voltage. At this time, the comparator changes states signaling the end of discharge. The time to discharge is proportional to the input voltage.

Dual-polarity operation has been added to this basic circuit by switching R2 to a $-10V$ reference or by using an op amp circuit that inverts the $+10V$ reference to create a negative reference, or by charging a capacitor with the $+10V$ reference and switching both ends of the capacitor to create a negative reference. The same result can be accomplished by

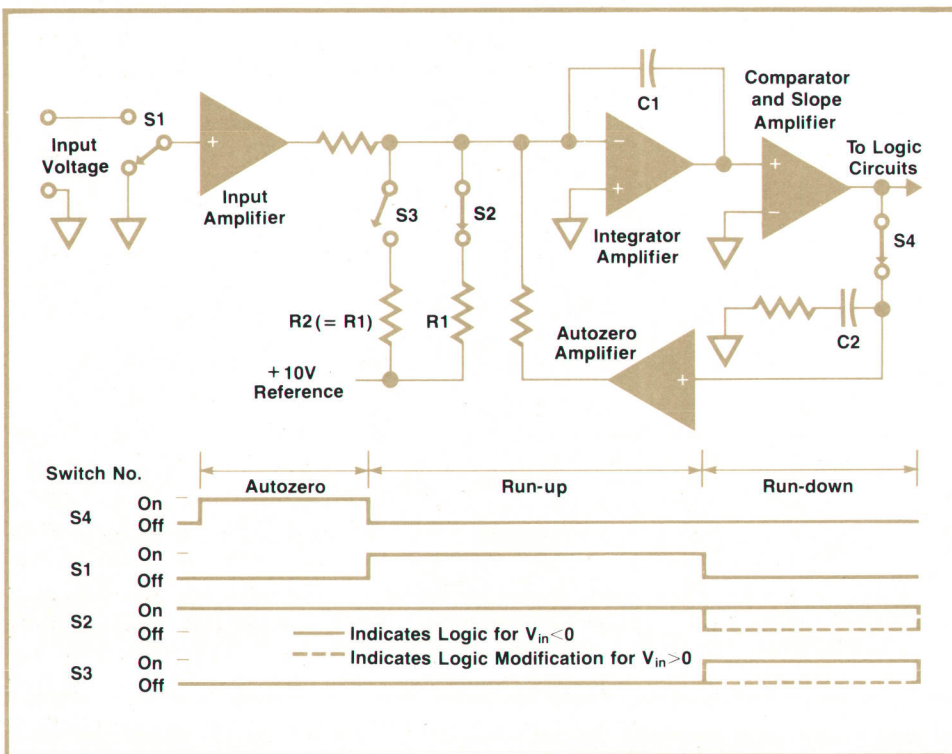

Fig. 5. Single-reference, dual slope A-to-D converter is autozeroed while switch S2 is closed. Opening S2 during integrator discharge is then equivalent to switching to a negative reference.

Extending the Ranges of a Digital Multimeter

Present-day digital multimeters typically have four to seven ranges for each function but by taking advantage of the high input impedances and low input bias currents characteristic of today's multimeters in the voltmeter mode, resistances and currents beyond those specified for the multimeter can be measured.

Very High Resistances

Resistances well into the gigaohm region are easily made with the aid of an external source and the set-up shown in the diagram. The multimeter is in the dc volts mode.

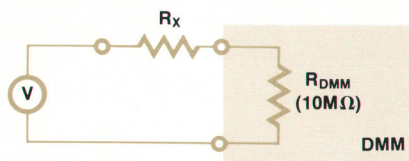

The unknown is found by evaluating the formula:

$$R_x = R_{DMM} \left(\frac{V_{SOURCE} - V_{DMM}}{V_{DMM}} \right)$$

For example, if V_{SOURCE} is 10V dc, R_{DMM} is 10 MΩ, and V_{DMM} is 100 mV,

$$R_x = 10 \text{ M}\Omega \left(\frac{10 - 0.1}{0.1} \right) = 990 \text{ M}\Omega$$

If the DMM input resistance is very high, say $> 10^{10}$, it is a simple matter to arrive at reasonable numbers by paralleling the input with a 10 MΩ resistor.

Very Low Currents

A digital multimeter can be used in the dc volts mode as a nanoammeter where the multimeter's input resistance serves as the current shunt, as shown in the diagram below.

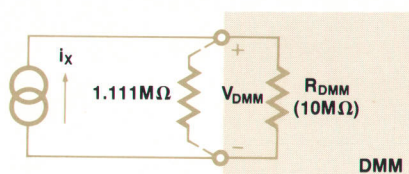

The unknown current, i_x , is derived by evaluating the formula:

$$i_x = \frac{V_{DMM}}{R_{DMM}}$$

If V_{DMM} were 100 mV and R_{DMM} were 10 MΩ, i_x would be 10 nA. If the input were paralleled by a 1.111 MΩ resistor, the effective R_{DMM} would be 1 MΩ and the multimeter would then read in nanoamperes directly.

Pitfalls

Obviously, a manufacturer could include these ranges in the original design. Why doesn't he? The primary limiting factor is input bias current. No matter how good the input amplifier may be, there is a small amount of bias current, typically 10 to 100 pA, that can interfere with the measurement, and this current can change drastically with temperature. A voltage reading taken with the unknown impedance connected while no signal is applied will indicate the amount of error attributable to the input bias current.

A second limiting factor is the voltage applied in the ohms mode. To prevent component damage in the circuit under test, the open-circuit voltage of most DMMs in the ohms mode is limited to 5 volts dc. No such constraint exists when an external source is used but the operator should evaluate the possibilities for damage beforehand. Also, if very high voltages are used for very high resistances, prudent shielding should be the rule and a high-quality capacitor ought to be connected across the multimeter input to reduce noise.

Trading Resolution for Reduced Burden

There are times when making measurements of current or resistance at less than 10% of full scale may result in more meaningful results. In measurements of current, for example, a typical voltage burden (voltage drop across the DMM input terminals) of 100 mV would be reduced to 10 mV by switching to the next higher range. Measurement accuracy and resolution are reduced by a factor of 10, but may still be high enough for many measurements. The disturbance to the measurement caused by the voltage burden, on the other hand, is also reduced, so measurement accuracy may actually be increased.

For resistance measurements, a typical 1-volt burden is reduced to 0.1 volt by going to the next higher range. In many instances this would reduce errors caused by conduction in solid-state devices, again enhancing accuracy.

using only R1 and S2, as shown in Fig. 5. S2 is left on during autozero so the effect of its current is nulled, just like other currents flowing into the integrator. S2 is left closed continuously until a negative current is required at the integrator. Then by opening S2, the removal of the precision positive current through R1 appears to the integrator like the application of a precision negative current.

Acknowledgments

Contributors to the design of the Model 3476A Digi-

tal Multimeter were Roy Buck, Tom Mills, Mike Allender, and Don Aupperle (industrial design); to the Model 3435A, Bill Hale, Gary Stadele, Bob Jarvis, Marsh Faber, Bob Moomaw, Bob Livengood, Ed Pennington, John Shea, Dave Connell, and Jim Berry (industrial design); to the Model 3465A, Craig Walters (Group leader), Ed Pennington, Francis Fiedler, Jim Fulbright, and John Pennington (industrial design). Bob Jeremiasen developed the fine-line, thin-film resistor sets. 

1- μ V Resolution in a Low-Cost 4½ Digit Multimeter

Model 3465A/B Digital Multimeter has a 20-mV full-scale dc voltage range that gives a resolution of 1 μ V, very useful for measuring the outputs of strain gages and thermocouples or drift in precision voltage sources. The maximum resolution on ac voltage measurements is 10 μ V, on measurements of current (ac or dc) it is 10 nA, and on resistance measurements, 10 m Ω . Open-circuit voltage on the most sensitive ohms range does not exceed 5 volts to prevent damage to most semiconductor devices.

Midrange dc accuracy is $\pm 0.02\% \pm 1$ digit. The frequency range for ac measurements is 40 Hz to 20 kHz.

Model 3465A/B is manual ranging with autopolarity and autozero. Like Model 3435A, it can work with the optional "touch-hold" probe to retain a measured value on display whenever the pushbutton on the probe is pushed.

This multimeter is available in two versions. Model 3465A is in a modular cabinet that is readily combined with other modules for rack mounting or bench stacking. It has a variety of power options, including rechargeable Nicad batteries with internal charger, throw-away type-D dry cells (alkaline cells give 60 hours continuous operation), or ac line. The dry-cell version can also operate on dc supplied from hand-held calculator battery chargers.

Model 3465B is housed in a streamlined plastic case with carrying handle. It is powered by ac line and rechargeable Nicad batteries.

Like Models 3476A and 3435A, Model 3465A/B achieves quality performance at low cost by extensive use of computer-aided testing, laser-trimmed fine-line resistors in the attenuator, and a single-reference bipolar A-to-D converter.

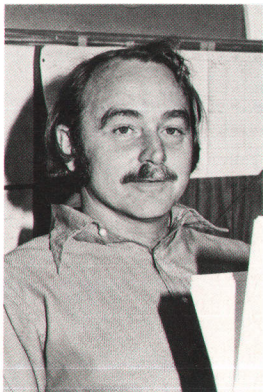
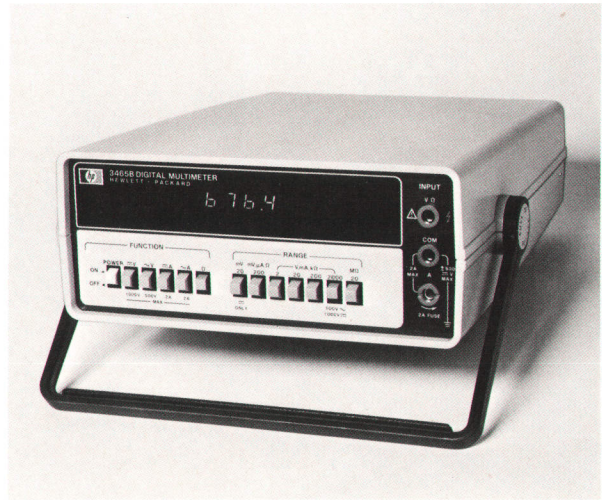

Roy D. Barker

Roy Barker graduated with a BSEE degree from the University of Oklahoma in 1962 and worked in satellite-tracking instrumentation and microwave data links before joining Hewlett-Packard in 1967. At HP, Roy was initially involved in production engineering, then became involved in IC design and production before becoming section manager for digital voltmeters. In his off hours, Roy likes to go cross-country skiing, often with his wife and 8-year-old son, and he also enjoys woodworking.



Virgil L. Laing

Virgil Laing first worked in IC development upon joining HP in 1968, subsequently becoming project leader for the NMOS process used for the 9800-series Calculator ROMs. He then designed a major part of the IC used in the 970A Probe Multimeter. Then he became project manager for the Model 3435A Multimeter. He has bachelor's, master's, and PhD degrees in electrical engineering, all from the University of Minnesota. Virgil enjoys the Colorado outdoors, going pheasant hunting and taking his family on hiking and camping trips.

HP Model 3476A/B Digital Multimeter

DC VOLTMETER

RANGE	ACCURACY (90 days, 20 to 30°C)
±0.110V	±(0.3% of reading + 2 digits)
±1.10V	±(0.3% of reading + 1 digit)
±11.0V	±(0.4% of reading + 1 digit)
±110V	±(0.4% of reading + 1 digit)
±1000V (1000V max)	

TEMPERATURE COEFFICIENT: ±(0.05% of reading + 0.2 digit)/°C.
COMMON MODE REJECTION (1kΩ unbalance): >100 dB at 50 Hz, 60 Hz.
INPUT RESISTANCE: 10 MΩ±5%.
INPUT PROTECTION: 1100V peak.

AC VOLTMETER

RANGE*	ACCURACY (90 days, 20 to 30°C; % of reading + no. of digits)		
	45 Hz to 2 kHz	2 to 5 kHz	5 to 10 kHz
0.110V	±(2% + 6)	±(5% + 6)	±(18% + 10)
1.10V			
11.00V	±(1.5% + 4)	±(3% + 6)	±(8% + 10)
110.0V (700V rms max)			

*Ranges usable above 3% of full scale

TEMPERATURE COEFFICIENT: ±(0.05% of reading + 0.5 digit)/°C.
COMMON MODE REJECTION (1kΩ unbalance): >80dB @ 50 Hz, 60 Hz.
INPUT RESISTANCE: 10 MΩ±5%.
INPUT CAPACITANCE: <30 pF.
INPUT PROTECTION: <1100V peak.

DC AMMETER

RANGE	ACCURACY (90 days, 20 to 30°C)
±0.110A	±(0.8% of reading + 2 digits)
±1.10A	±(0.8% of reading + 2 digits)

TEMPERATURE COEFFICIENT: ±(0.05% of reading + 2 digit)/°C.
IMPEDANCE: 1—1.5 ohm constant
CURRENT PROTECTED: 1.5A fuse.

AC AMMETER

RANGE*	ACCURACY (90 days, 20 to 30°C; % of reading + no. of digits)		
	45 Hz to 2 kHz	2 to 5 kHz	5 to 10 kHz
1.1A	±(2% + 4)	±(3.5% + 6)	
0.11A	±(2.5% + 6)	±(5.5% + 6)	

*Ranges usable above 3% of full scale.

TEMPERATURE COEFFICIENT: ±(0.05% of reading + 0.5 digit)/°C.
IMPEDANCE: 1—1.5 ohm constant.
CURRENT PROTECTED: 1.5A fuse.

OHMMETER

RANGE	ACCURACY (90 days, 20 to 30°C)
1.1 kΩ	±(0.5% of reading + 1 digit)
11 kΩ	±(0.5% of reading + 1 digit)
110 kΩ	±(0.3% of reading + 1 digit)
1100 kΩ	±(0.5% of reading + 1 digit)
11,000 kΩ	±(0.5% of reading + 1 digit)

TEMPERATURE COEFFICIENT: ±(0.05% of reading + 0.2 digit)/°C.
OPEN CIRCUIT VOLTAGE: <5V.
INPUT VOLTAGE PROTECTION: <30 Vrms continuous, fuse protected from 30V to 250Vrms.

General

RANGING: Automatic, Range Hold.
OVERLOAD INDICATION: Horizontal bars.
COMMON TO GROUND: -500 V (peak).
SAMPLE RATE: -3/second.
OPERATING ENVIRONMENTAL CONDITIONS: 0 to 40°C, <95% RH.
POWER: 3476A and 3476B ac line, <6 VA.
STANDARD 104-127V; 54-66 Hz
OPTION 001 86-106V; 54-66 Hz
OPTION 002 86-106V; 48-54 Hz
OPTION 003 190-230V; 48-54 Hz
OPTION 004 208-250V; 48-54 Hz
3476B BATTERIES: 4 rechargeable nickel cadmium sub-C size. Typical continuous operating time using fully charged batteries: 8 hours at 25°C.
Typical battery charging time: 14 hours at 25°C with instrument turned off. Trickle charge with instrument on.

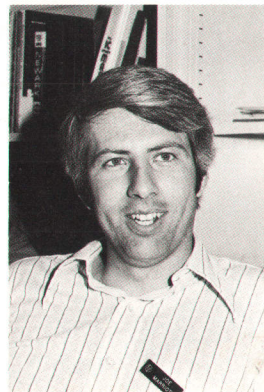

Joe E. Marriott

A 1969 graduate of the University of Utah (BSEE), Joe Marriott joined HP that same year, going to work on the Model 3403A True-rms Voltmeter. Returning to HP following a tour of duty with the National Guard, Joe contributed to the 970A and 3465A Voltmeters. While working on the 3476A/B Joe became project manager. Along the way, he earned an MSEE degree at Colorado State University in the HP Honors Co-op program. Married, and with a 2-year-old daughter, Joe cross-country skis, hikes, plays volleyball, and occasionally does some photography.

country skis, hikes, plays volleyball, and occasionally does some photography.

SPECIFICATIONS

WEIGHT: 3476A, 0.77kg (1 lb, 11 oz.); 3476B, 0.97kg (2 lb, 2 oz.).
DIMENSIONS: 58 mm high x 168 mm wide x 206 mm deep (2.3 03302.6 03302.8 inches).
PRICES IN U.S.A.: 3476A, \$225, 3476B, \$275.

HP Model 3435A Digital Multimeter DC Voltmeter

Ranges	Maximum Display
±200mV	±199.9mV
±2V	±1.999V
±20V	±19.99V
±200V	±199.9V
±1200V	±1199V

SENSITIVITY: 100μV on 200mV range.
MAXIMUM INPUT: 1200V (dc + peak ac).
RANGING: Automatic or manual.
POLARITY: Automatically sensed and displayed.
ACCURACY (1 year, 15 to 30°C at 95% RH):

Range	Specifications
200mV	±(0.1% of reading + 2 digits)
2V to 1200V	±(0.1% of reading + 1 digit)

TEMPERATURE COEFFICIENT (0 to 15°C and 30 to 55°C): ±(0.018% reading + 0.1 digit)/°C.
INPUT RESISTANCE: 10 MΩ±1%.

INPUT TYPE: Floating, 500V maximum, common to ground.

NORMAL MODE REJECTION: 40dB at 50/60 Hz ±1 Hz.
EFFECTIVE COMMON MODE REJECTION (1kΩ unbalance): >120 dB at 50/60 Hz ±0.1%.

RESPONSE TIME: <0.7 seconds to within 1 digit of final value on one range. Add 1 second for each range change.

DC Current

Ranges	Maximum Display
±200μA	±199.9μA
±2mA	±1.999mA
±20mA	±19.99mA
±200mA	±199.9mA
±2000mA	±1999mA

SENSITIVITY: 100nA on 200μA range.
MAXIMUM INPUT: Current, 2A (fuse protected); voltage, 250V.
RANGING: Manual only.
POLARITY: Automatically sensed and displayed.
ACCURACY (1 year, 15 to 30°C at 95% RH):

Range	Specifications
200μA to 20 mA	±(0.3% of reading + 2 digits)
2000mA	±(0.6% of reading + 2 digits)

TEMPERATURE COEFFICIENT (0 to 15°C and 30 to 55°C): ±(0.02% of reading + 0.1 digit)/°C
VOLTAGE BURDEN:

Range	Maximum at Full Scale
200μA to 20mA	<220mV
200mA	<240mV
2000mA	<400mV

RESPONSE TIME: 0.7 seconds on any range to within 1 digit of final value.

AC Voltmeter

AC CONVERTER: Average responding, rms calibrated.

Ranges	Maximum Display
200mV	199.9mV
2V	1.999V
20V	19.99V
200V	199.9V
1200V	1199V

SENSITIVITY: 100μV on 200mV range.
MAXIMUM INPUT: 1700V (dc + peak ac), 10⁷ volt-Hz max.
RANGING: Automatic or manual.
ACCURACY (with display of ≥20 digits; 1 year, 15 to 30°C at 95% RH):

Range	Specifications
30 Hz—50 Hz	±(1.5% of reading ± 3 digits)
50 Hz—20 kHz	±(0.2% of reading ± 3 digits)
20 kHz—100kHz	±(1.5% of reading ± 10 digits)

TEMPERATURE COEFFICIENT (0 to 15°C and 30 to 55°C): ±(0.04% of reading + 0.2 digit)/°C.
INPUT IMPEDANCE: 5 MΩ/50 pF.

RESPONSE TIME: 1.6 seconds to within 3 digits of final value on one range. Add 1.2 seconds for each range change.
INPUT TYPE: Floating, 500V maximum common to ground.

AC Current

Ranges	Maximum Display
200μA	199.9μA
2mA	1.999mA
20mA	19.99mA
200mA	199.9mA
2000mA	1999mA

MAXIMUM INPUT: Current, 2 A (fuse protected); voltage, 250V.

RANGING: Manual only.

SENSITIVITY: 100nA on 200μA range.

ACCURACY (with display of ≥20 digits; 1 year, 15 to 30°C @ 95% RH):

Range	Specification
	(% of reading + no. of digits)
2000mA	±(2% + 4)
200mA	±(1.7% + 4)
200μA	±(0.9% + 4)

30 Hz 50 Hz 10 kHz

Frequency of Input Signal

TEMPERATURE COEFFICIENT (0 to 15°C and 30 to 55°C): ±(0.05% of reading + 0.2 digits)/°C.

VOLTAGE BURDEN:

Range	Maximum at Full Scale
200μA to 20mA	<220mV rms
200mA range	<240V rms
2000mA range	<400V rms

RESPONSE TIME: 1.6 seconds on any range to within 3 digits of final value.
INPUT TYPE: Floating, 500V maximum common to ground.

Ohmmeter

Ranges	Maximum Display
20Ω	19.99Ω
200Ω	199.9Ω
2 kΩ	1.999 kΩ
20 kΩ	19.99 kΩ
200 kΩ	199.9kΩ
2MΩ	1.999MΩ
20MΩ	19.99MΩ

SENSITIVITY: 10 milliohm on 20Ω range.

INPUT PROTECTION: 250V rms.

RANGING: Automatic or manual.

ACCURACY (1 year, 15 to 30°C @ 95% RH):

Range	Specifications
200Ω—2MΩ	±(0.5% of reading + 10 digits)
20MΩ	±(0.2% of reading + 2 digits)
20MΩ	±(0.8% of reading + 2 digits)

TEMPERATURE COEFFICIENT (0 to 15°C and 30 to 55°C):

Range	Specifications
20Ω—2MΩ	±(0.04% of reading + 0.2 digits)/°C
20MΩ	±(1.8% of reading + 0.2 digits)/°C

CONFIGURATION: 2 wire.

OPEN CIRCUIT VOLTAGE: <5V.

CURRENT THROUGH UNKNOWN:

Range: 20Ω 200Ω 2 kΩ 20 kΩ 2 MΩ 20 MΩ
Current: 5mA 5mA 500μA 5μA 500nA 50nA

RESPONSE TIME: 0.8 seconds to within 1 digit. Add 0.8 seconds for each range.

General

CALIBRATION: Data sheet specifications guaranteed for 1 year.

READING RATE: 2.4—1.7/sec, depending on input level.

OPERATING TEMPERATURE: 0 to 55°C.

HUMIDITY: 95% RH, +15 to -40°C.

POWER: AC line: 48-440 Hz; 86-250V

BATTERY: rechargeable lead-acid 10 hours minimum continuous operation with full charge. Recharge time: 16 hours operating, 12 hours nonoperating.

TOTAL INSTRUMENT POWER DISSIPATED: ac only; 3 watts; with charger, 8 watts.

DIMENSIONS: 238.1 mm wide × 98.4 mm high × 276.2 mm deep (9-3/8 × 3 3/4 × 10 3/4 inches). Opt 002, 210 × 85.7 × 26.7 mm (8 1/4 × 3 3/8 × 1 1/4 in).

WEIGHT: 2.41 kg (5 lb, 5 oz); Opt 001, 1.84 kg (4 lb, 1 oz).

PRICES IN U.S.A.: 3435A, \$400; without batteries (Opt. 001), less \$65. Rack-and-stack case Opt 002 (ac line power only), less \$35. 34112A Touch-Hold Probe, \$40.



H. Mac Juneau

Mac Juneau joined HP in 1967, going to work on the Model 3480A Digital Voltmeter and then on high-speed A-to-D converters as project manager. For three years, Mac was product assurance manager with time out as project manager for the Model 3476A Multimeter. He is now manager of the HP Loveland facilities IC lab. He has a BSEE degree from Swarthmore College (Philadelphia) and MSEE and PhD degrees from the University of Minnesota. With children 8 and 5, Mac contributed to a school playground design. He also does some woodworking and creates welded sculptures.

SPECIFICATIONS

HP Model 3465A/B Digital Multimeter

DC Voltmeter

Ranges	Maximum Display
±20mV	19.999
±200mV	199.99
±2V	1.9999
±20V	19.999
±200V	199.99
±1000V	1000.0

SENSITIVITY: 1 microvolt on lowest range.
MAXIMUM INPUT: 1000V max dc and peak ac.
POLARITY: Automatically sensed and displayed.
ACCURACY (1 year, 23°C ± 5°C at 95% RH):

Range	Specifications
20mV	±0.03% of reading ± 2 digits
200mV thru 200V	±0.02% of reading ± 1 digit
1000V	±0.025% of reading ± 1 digit

TEMPERATURE COEFFICIENT (0°C to 50°C):
 ±0.003% of reading/°C.

INPUT RESISTANCE:

Range	Specifications
20mV thru 2V	>10 ¹⁰ Ω
20V thru 1000V	10MΩ ± 1%

INPUT TYPE: floating, 500V maximum common to ground.
NORMAL MODE REJECTION: >60 dB at 50/60 Hz ± 1%
EFFECTIVE COMMON MODE REJECTION (1 kΩ unbalance): >120 dB at 50/60 Hz ± 1%
RESPONSE TIME: 1 second to within 1 digit.

DC Current

Ranges	Maximum Display
±200μA	199.99
±2mA	1.9999
±20mA	19.999
±200mA	199.99
±2000mA	1999.9

SENSITIVITY: 10nA on lowest range.
MAXIMUM INPUT: 2A from <250V source (fuse protected).
POLARITY: Automatically sensed and displayed.
ACCURACY (1 year, 23°C ± 5°C at 95% RH):

Range	Specifications
200μA, 2mA	±0.07% of reading ± 1 digit
20mA	±0.11% of reading ± 1 digit
200mA, 2000mA	±0.6% of reading ± 1 digit

TEMPERATURE COEFFICIENT (0°C to 50°C):

Range	Specifications
200μA	±0.006% of reading/°C
2mA, 20mA	±0.004% of reading/°C
200mA, 2000mA	±0.01% of reading/°C

VOLTAGE BURDEN

HIGHEST RANGE: <700mV FS.
 ALL OTHER RANGES: <250mV FS.
RESPONSE TIME: 1 second to within 1 digit.

Ohmmeter

Ranges	Maximum Display
200Ω	199.99
2 kΩ	1.9999
20 kΩ	19.999
200 kΩ	199.99
2000 kΩ	1999.9
20 MΩ	19.999

SENSITIVITY: 10 milliohm on lowest range.
INPUT PROTECTION: 350V (dc + peak ac)/250V rms.
ACCURACY (1 year, 23°C ± 5°C @ 95% RH):

Range	Specifications
200Ω	±0.02% of reading ± 2 digits
2 kΩ thru 2 MΩ	±0.02% of reading ± 1 digit
20 MΩ	±0.1% of reading ± 1 digit

TEMPERATURE COEFFICIENT (0°C to 50°C):

Range	Specifications
200Ω thru 2 MΩ	±0.0015% of reading/°C
20 MΩ	±0.004% of reading/°C

CONFIGURATION: 2 wire.
OPEN CIRCUIT VOLTAGE: <5V max.
CURRENT THROUGH UNKNOWN:

Range	Current
200Ω	1mA
2 kΩ	1mA
20 kΩ	10 μA
200 kΩ	10 μA
2000 kΩ	1 μA
20 MΩ	0.1 μA

RESPONSE TIME: 2 seconds to within 1 digit.

AC Voltmeter

AC CONVERTER: average responding, rms calibrated.

Ranges	Maximum Display
200 mV	199.99
2V	1.9999
20V	19.999
200V	199.99
500V	500.0

SENSITIVITY: 10μV on lowest range.
MAXIMUM INPUT: Full scale to 10 kHz decreasing linearly to 50% of full scale at 20 kHz except 500V range which has 2-kHz maximum frequency.
ACCURACY (1 year, 23°C ± 5°C @ 95% RH):

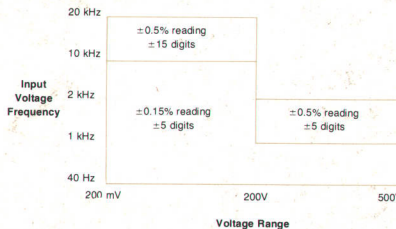

TEMPERATURE COEFFICIENT (0°C to 50°C):
 ±0.005% of reading ± 2 digit.

INPUT IMPEDANCE: 1 MΩ/ <100 pF.
INPUT TYPE: floating, 500V maximum common to ground.
OVERLOAD PROTECTION: dc, 600V max; ac, 500V rms, 800V peak.
RESPONSE TIME: 5 seconds to within 1 digit.

AC Current

Range	Maximum Display
200μA	199.99
2mA	1.999
20mA	19.999
200mA	199.99
2000mA	1999.9

SENSITIVITY: 10nA on lowest range.
MAXIMUM INPUT: 2A from <250V source (fuse protected). Full scale to 10 kHz decreasing linearly to 50% full scale at 20 kHz on lowest 3 ranges, 2 kHz max on 200mA range; 1 kHz max on 2000mA range.
ACCURACY (1 year, 23°C ± 5°C @ 95% RH):

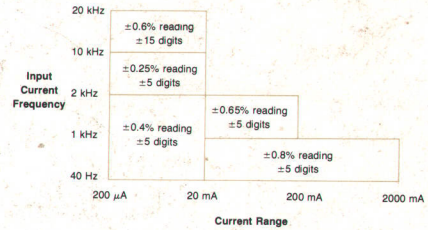

TEMPERATURE COEFFICIENT (0°C to 50°C): ±0.01% of reading/°C.

VOLTAGE BURDEN:

1A RANGE: <700mV fs.
 ALL OTHER RANGES: <250mV fs.
RESPONSE TIME: 5 seconds to within 1 digit.

General

READING RATE: 2½ readings per second.
OVERLOAD INDICATION: display blanks.
HUMIDITY RANGE: 95% at 40°C
OPERATING TEMPERATURE: 0°C to +55°C (nickel-cadmium batteries, 0°C to +40°C).
WEIGHT: 2.04 kg (4 lbs., 8 oz.).
DIMENSIONS: 101.6 mm high × 212.7 mm wide × 279.4 mm deep (4 × 8-3/8 × 11 in.).
POWER: ac line, 86-127V, 176-250V; 48-440 Hz.
BATTERIES: rechargeable nickel cadmium standard.
 Continuous operating time from full charge is 8 hours. Recharge time is 8 hours with instrument off. Trickle charge with instrument on.
OPTION 002: type D alkaline dry cells (U-2 cells in Europe). 60 hours continuous use at 23°C. Includes receptacle to use Model 82002A battery eliminator (82002A not included).
PRICE IN U.S.A.:
 3465A, \$530; Opt. 001: ac line only, -\$20; Opt. 002, -\$105.
 3465B, \$530; 34112 Touch-Hold Probe, \$40.
MANUFACTURING DIVISION: LOVELAND INSTRUMENT DIVISION
 815 Fourteenth Street S.W.
 Loveland, Colorado 80537 U.S.A.

Hewlett-Packard Company, 1501 Page Mill Road, Palo Alto, California 94304

HEWLETT-PACKARD JOURNAL

FEBRUARY 1977 Volume 28 • Number 6

Technical information from the Laboratories of Hewlett-Packard Company

Hewlett-Packard Central Mailing Department
 Van Heuven Goedhartlaan 121
 Amstelveen-1134 The Netherlands
 Yokogawa-Hewlett-Packard Ltd., Shibuya-Ku
 Tokyo 151 Japan

Editorial Director • Howard L. Roberts
 Managing Editor • Richard P. Dolan
 Art Director, Photographer • Arvid A. Danielson
 Illustrator • Susan E. Wright
 Administrative Services, Typography • Anne S. LoPresti
 European Production Manager • Tina Eysten

Bulk Rate
 U.S. Postage
 Paid
 Hewlett-Packard
 Company

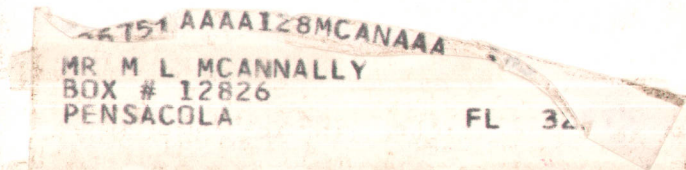

CHANGE OF ADDRESS: To change your address or delete your name from our mailing list please send us your old address label (it peels off). Send changes to Hewlett-Packard Journal, 1501 Page Mill Road, Palo Alto, California 94304 U.S.A. Allow 60 days.